

See discussions, stats, and author profiles for this publication at: <https://www.researchgate.net/publication/333806326>

Streamlining Cross-Organizational Aircraft Development: Results from the AGILE Project

Conference Paper · June 2019

DOI: 10.2514/6.2019-3454

CITATIONS

0

READS

95

21 authors, including:



[Prajwal Shivaprakasha](#)

German Aerospace Center (DLR)

16 PUBLICATIONS 38 CITATIONS

[SEE PROFILE](#)



[Thierry Lefebvre](#)

The French Aerospace Lab ONERA

27 PUBLICATIONS 111 CITATIONS

[SEE PROFILE](#)



[Nathalie Bartoli](#)

The French Aerospace Lab ONERA

51 PUBLICATIONS 273 CITATIONS

[SEE PROFILE](#)



[Huub Timmermans](#)

Netherlands Aerospace Centre

3 PUBLICATIONS 1 CITATION

[SEE PROFILE](#)

Some of the authors of this publication are also working on these related projects:



RETALT "RETro propulsion Assisted Landing Technologies" [View project](#)



European platform for innovation and collaboration between engineer students (EPICES) [View project](#)

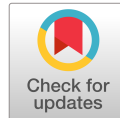

Streamlining Cross-Organizational Aircraft Development: Results from the AGILE Project

Pier Davide Ciampa¹, Prajwal Shiva Prakasha², Francesco Torrigiani³, Jan-Niclas Walther⁴
DLR, German Aerospace Center, Institute of System Architectures in Aeronautics, Hamburg, Germany

Thierry Lefebvre⁵, Nathalie Bartoli⁶
ONERA, The French Aerospace Lab, Toulouse, France

Huib Timmermans⁷
NLR, Netherlands Aerospace Centre, Aerospace Vehicles division, Amsterdam, The Netherlands

Pierluigi Della Vecchia⁸, Luca Stingo⁹
University of Naples Federico II, Department of Industrial Engineering, Naples, Italy

Darwin Rajpal¹⁰, Imco van Gent¹¹, Gianfranco La Rocca¹²
TU Delft, Faculty of Aerospace Engineering, Delft, The Netherlands

Marco Fioriti¹³
Politecnico di Torino, Turin, Italy

Giovanni Cerino¹⁴
LEONARDO Company, Aircraft Division, Italy

Reinhold Maierl¹⁵
AIRBUS Defence and Space, Germany

Dominique Charbonnier¹⁶, Aidan Jungo¹⁷
CFS Engineering, EPFL Innovation Park, Lausanne, Switzerland

Benedikt Aigner¹⁸
RWTH, Institute of Aerospace Systems, Aachen, Germany

Kirill Anisimov¹⁹
TsAGI, Zhukovsky, Moscow Region, Russia

¹ Head of MDO Group, Aircraft Design & System Integration, pier-davide.ciampa@dlr.de, AIAA MDO TC member

² Research Engineer, Aircraft Design & System Integration Department, AIAA member

³ Research Engineer, Aircraft Design & System Integration Department

⁴ Research Engineer, Aircraft Design & System Integration Department

⁵ Research Engineer, Information Processing and Systems Department, AIAA member

⁶ Research Engineer, Information Processing and Systems Department, AIAA MDO TC member

⁷ R&D Engineer, Flight Physics Department

⁸ Assistant Professor, Department of Industrial Engineering, pierluigi.dellavecchia@unina.it, AIAA member

⁹ PhD Student, Department of Industrial Engineering, luca.stingo@unina.it, AIAA student member

¹⁰ PhD Student, Aircraft Structures and Computational Mechanics

¹¹ PhD Student, Flight Performance and Propulsion Section, AIAA student member

¹² Assistant Professor, Flight Performance and Propulsion Section, AIAA member

¹³ Assistant Professor, Aerospace Department (DIMEAS), AIAA member

¹⁴ Civil transport aircraft preliminary design coordinator

¹⁵ Structure Analysis and Optimization Engineer, Stress Methods & Optimization

¹⁶ Senior Scientist, dominique.charbonnier@cfse.ch, AIAA member

¹⁷ Research Scientist

¹⁸ PhD Student, Institute of Aerospace Systems

¹⁹ Researcher, Propulsion Systems Aerodynamics Department, AIAA member

Artur Mirzoyan²⁰
CIAM, Moscow, Russia

Mark Voskuijl²¹
Netherlands Defence Academy, Faculty of Military Sciences, Den Helder, The Netherlands

The research and innovation AGILE project developed the next generation of aircraft Multidisciplinary Design and Optimization processes, which target significant reductions in aircraft development costs and time to market, leading to more cost-effective and greener aircraft solutions. The high level objective is the reduction of the lead time of 40% with respect to the current state-of-the-art. 19 industry, research and academia partners from Europe, Canada and Russia developed solutions to cope with the challenges of collaborative design and optimization of complex products. In order to accelerate the deployment of large-scale, collaborative multidisciplinary design and optimization (MDO), a novel methodology, the so-called AGILE Paradigm, has been developed. Furthermore, the AGILE project has developed and released a set of open technologies enabling the implementation of the AGILE Paradigm approach. The collection of all the technologies constitutes AGILE Framework, which has been deployed for the design and the optimization of multiple aircraft configurations. This paper focuses on the application of the AGILE Paradigm on seven novel aircraft configurations, proving the achievement of the project's objectives.

Nomenclature

<i>AGILE</i>	= Aircraft 3rd Generation MDO for Innovative Collaboration of Heterogeneous Teams of Experts
<i>DC</i>	= Design Campaign (within AGILE Project)
<i>DOC</i>	= Direct Operating Costs
<i>DOE</i>	= Design of Experiments
<i>CPACS</i>	= Common Parametric Aircraft Configuration Schema
<i>MDA</i>	= Multidisciplinary Design Analysis
<i>MDO</i>	= Multidisciplinary Design Optimization
<i>MBSE</i>	= Model Based Systems Engineering
<i>OAD</i>	= Overall Aircraft Design
<i>PIDO</i>	= Process Integration and Design Optimization
<i>PDP</i>	= Product Development Process
<i>SOA</i>	= Service Oriented Architecture
<i>TLAR</i>	= Top Level Aircraft Requirements
<i>XDSM</i>	= eXtended Design Structure Matrix

I. Introduction

Current aircraft development programs are realized as collaborative and multi-organizational design processes. A major challenge hampering cost effective design processes is the integration of multidisciplinary competences within the so-called virtual enterprise. The challenge is even greater when the required design services are provided by heterogeneous teams of specialists that are distributed among different organizations, and across nations. On the other hand, by nature, individual SME, IND, RES and HES alone can neither establish all the necessary competences nor system competence. Therefore, the development of a “more competitive supply chain” is the key-enabler to deliver innovative aircraft products in a time and cost-efficient manner. Within this context, Multidisciplinary Design and Optimization (MDO) is a key enabler for the development of innovative aeronautical products. The state-of-the-art MDO capabilities relies on high performance computing infrastructures, efficient optimization strategies, sophisticated simulation-based analyses in all the flight physics domains, and robust process management frameworks. Nevertheless, the exploitation of the full MDO potentials for the development of a complete aircraft is still an open challenge. Analyzing the current generation of MDO design systems, the authors have identified that major obstacles are largely related to the efforts required to setup and deploy (more than resolve) the complex collaborative development process. Ciampa et al. [1] quantified that 60% to 80% of the project time may be necessary to

²⁰ Head of Department, Propulsion and A/C Matching Department, AIAA member

²¹ Professor, Faculty of Military Sciences, AIAA member

setup such a process. Many of the related challenges are addressed in the AGILE (Aircraft 3rd Generation MDO for Innovative Collaboration of Heterogeneous Teams of Experts) [2] EU funded H2020 research and innovation project, coordinated by the German Aerospace Center (DLR). AGILE project has developed the next generation of aircraft MDO processes, which target significant reductions in aircraft development costs and time to market, leading to more cost-effective and greener aircraft solutions. AGILE has formulated a novel design methodology, the so called “AGILE Paradigm” [3], accelerating the deployment of collaborative, large scale design and optimization frameworks, and a collection of technologies, named AGILE Framework, enabling the implementation and application of the methodology. This paper presents the overall results achieved by the end of the project focusing on the novel aircraft design and optimization problems resolved. A brief overview on the AGILE project and the developed AGILE Paradigm methodology is introduced in Section 2. Section 3 presents the multiple aircraft design MDO applications formulated and resolved during the project as use-cases of for the AGILE technologies. Section 4 reports the main results for all the unconventional aircraft configurations developed. Section 5 discusses the overall progresses and the achievement from the project. Finally, Section 6 provides a brief outlook of needs beyond the AGILE project and which are concern of follow-on activities.

II. AGILE Project and AGILE Paradigm

AGILE [2] has developed Multidisciplinary Design and Optimization technologies, enabling significant reductions in aircraft development costs and time to market, leading to cost-effective and greener aircraft solutions. The project, funded by the EU Horizon 2020 scheme, has started on June 2015 and concluded on November 2018.

A. High level objectives

The overall AGILE project objective is to achieve a significant reduction in aircraft development costs through a more competitive supply chain able to reduce the time to market of innovative aircraft products.

The ambition is to advance the state-of-the-art in solving the design and optimization of complex, challenging design problems, such as the development of novel aircraft products, by integration of MDO techniques, collaboration and knowledge-based technologies. AGILE has set ambitious performance targets to achieve by the end of the project: a reduction of 20% in time to converge the optimization of an aircraft and a 40% reduction in time needed to setup and solve the multidisciplinary optimization in a team of heterogeneous specialists.

B. The AGILE Consortium

The AGILE team is composed of 19 industry, research and academia partners from Europe, Canada and Russia, which have joined their efforts to cope with the challenges of collaborative product development. The composition of the AGILE consortium reflects the heterogeneous structure characteristic of today’s aircraft development teams and virtual supply chains: it includes airframe OEMs, suppliers, as well as organizations providing specialist design teams. Due to the diversity of partners, multiple collaborative scenarios are formulated and resolved during the project. The geographical distribution of the partners accentuates the collaboration challenges. The overall AGILE Consortium represents a collaborative MDO network, which is illustrated in Fig. 1.



Fig. 1 AGILE Consortium - A collaborative MDO network

C. AGILE Paradigm and AGILE Framework

In order to enable the third generation of MDO and to accelerate the deployment of large-scale, collaborative multidisciplinary design and optimization processes, a novel methodology, the so-called “AGILE Paradigm”[3] has been developed. The AGILE Paradigm ambition is:

- Accelerating the setup and the deployment of distributed, cross-organizational MDO processes
- Supporting the collaborative operation of MDO systems: integrating specialists and tools
- Exploiting the potentials offered by the latest technologies in collaborative design and optimization

The AGILE Paradigm is defined as a “blueprint for MDO” guiding the deployment and the execution of collaborative “MDO systems” for complex products practiced by cross-organizational design teams, distributed multi-site, and with heterogeneous expertise. Therefore, as blueprint, the AGILE Paradigm provides a methodology which prescribes a series of questions and practices to facilitate the deployment of an MDO system, it indicates how to structure the development of a complex product, it defines the roles of all the stakeholders engaged in the development, and it indicates how to streamline the interfaces and the interactions within the entire supply chain (data, models, and resources involved). An overall structure of the AGILE Paradigm is illustrated in Fig. 2. Details on the architectural elements of the AGILE Paradigm methodologies are reported in [4].

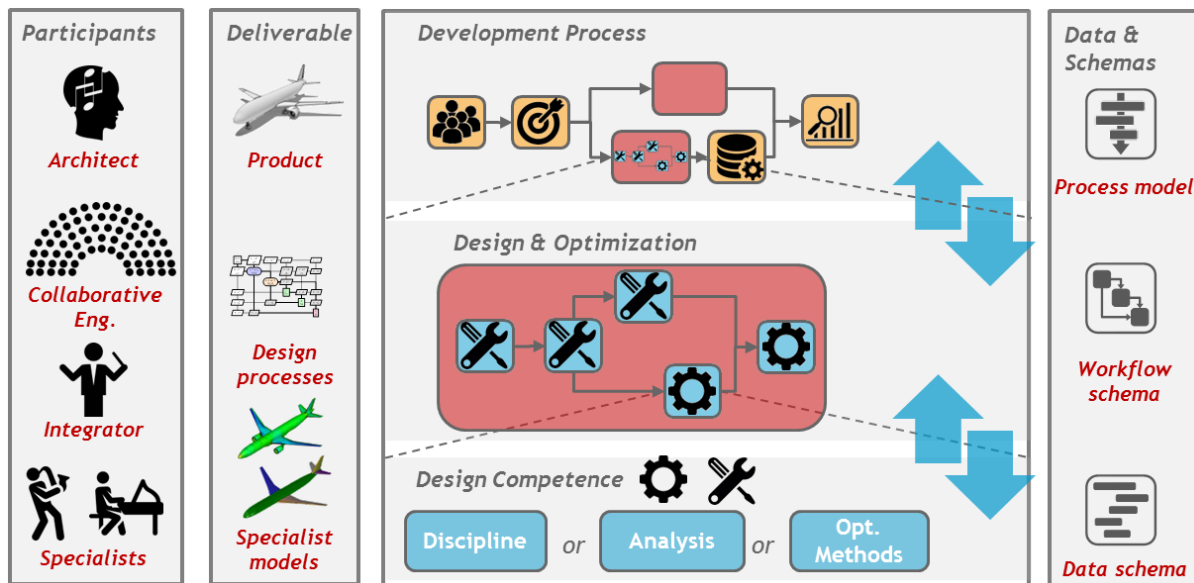

Fig. 2 AGILE Paradigm - Overall Structure of MDO Systems [4].

The AGILE Paradigm is formulated in a generalized way in order to be applicable to the design and optimization of aircraft (or sub-components) as well as other complex systems. Furthermore, the AGILE project has developed a set of technologies enabling the implementation of the AGILE Paradigm approach. The collection of all the technologies constitutes “AGILE Framework. Each of the technologies targets a specific step of the AGILE Development Process, which establishes phases and tasks needed to deploy an MDO system, ”, as illustrated in Fig. 3.

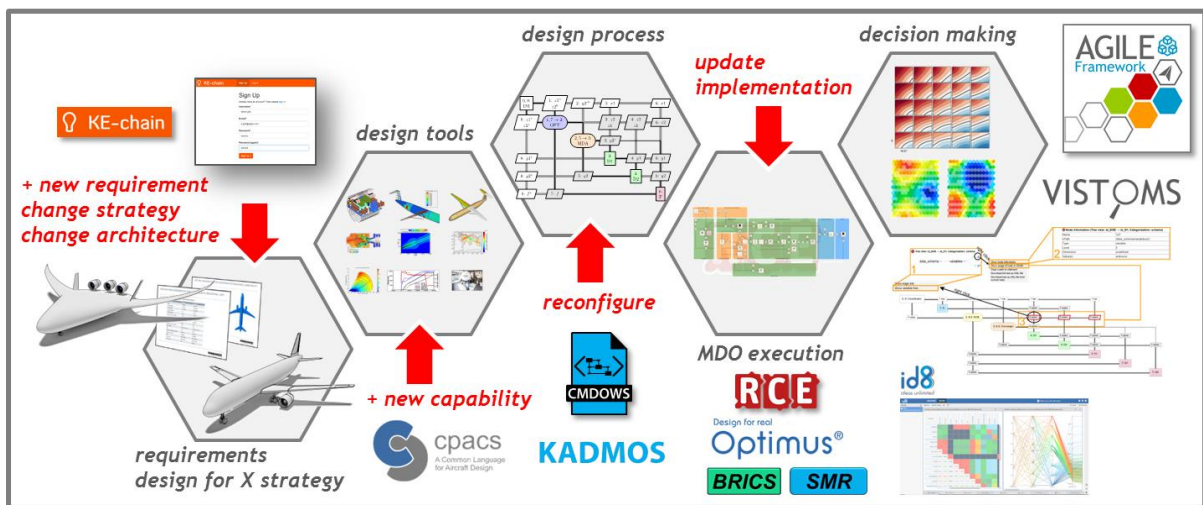

Fig. 3 AGILE Framework

The AGILE technologies have enabled the consortium to setup and resolve multiple complex aircraft MDO problems, starting with the specification of the Top Level Aircraft Requirements (TLAR) provided by the aircraft manufacturer, and including Overall Aircraft Design (OAD) processes targeting conceptual and preliminary development. All the design tools and competences are hosted in different organizations and integrated within the MDO processes as remote engineering services [5]. Fig. 4 shows a representation of the distributed cross-organizational OAD process. The figure indicates the domains of the specialists' competences which have been integrated into the process, the location where such simulation competences are hosted, and the specific partners providing such a competence within their IT facilities. The pool of design competences available in the consortium comprises design modules for overall aircraft synthesis at the conceptual design stages, and disciplinary simulation capabilities covering multiple levels of complexity and details. The disciplinary simulation capabilities include, among others, aerodynamics and structural solvers, propulsion and on-board systems design tools, flight dynamics simulation models.

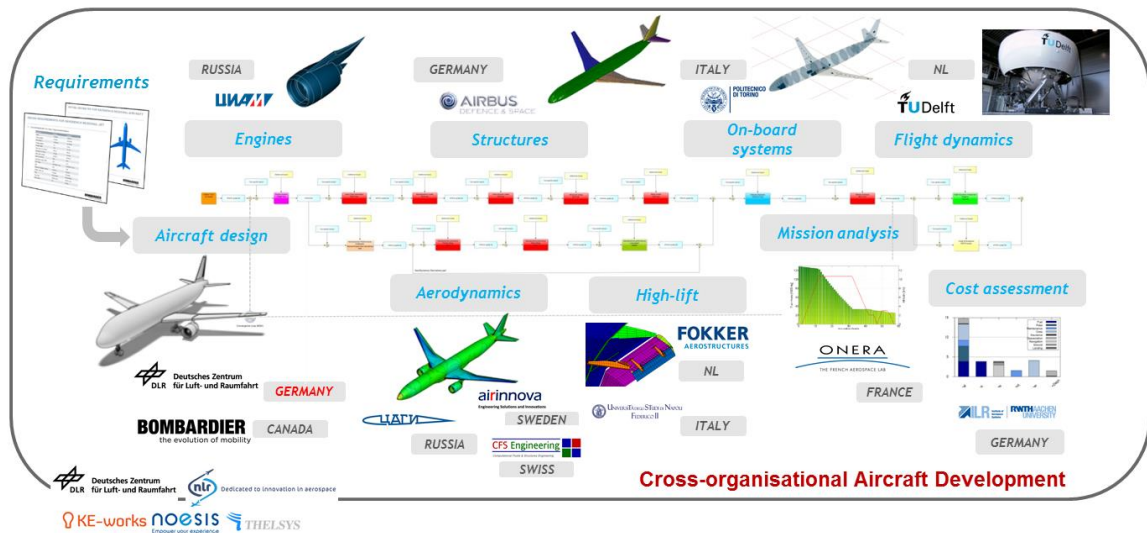

Fig. 4 AGILE Collaborative cross-organizational design process: individual competences are distributed multi-site, and hosted at different partner's networks.

D. AGILE Design Campaigns

AGILE is structured into three sequential phases, named as Design Campaigns (DC), with increasing complexity from aircraft configuration perspective (progressing from conventional aircraft to novel configurations), and MDO environment perspective (from the current state-of-the-art to the 3rd generation system). During each design campaign, the design system is enhanced by a step forward the full realization of the next generation of MDO processes.

In the phase 1 (DC-1 Month 01 - Month 15) the AGILE team has deployed the reference distributed MDO system and executed the optimization workflow according to today's best practice. The reference aircraft is a conventional configuration (Entry Into Service 2020).

In the phase 2 (DC-2 Month 16 – Month 27) different optimization techniques and scenarios are investigated using the reference MDO framework and the reference aircraft (same conventional configuration from DC-1).

In the phase 3 (DC-3 Month 28 – Month 42) the complete AGILE Framework is applied to multiple novel aircraft configurations to be developed in parallel.

Fig. 5 shows a schematic of the AGILE Design Campaigns, highlighting the advancements of the design system and use cases addressed by each design campaign. This paper focuses on the achievements from phase 3, whereas results from the previous phases are available in [3], [6].

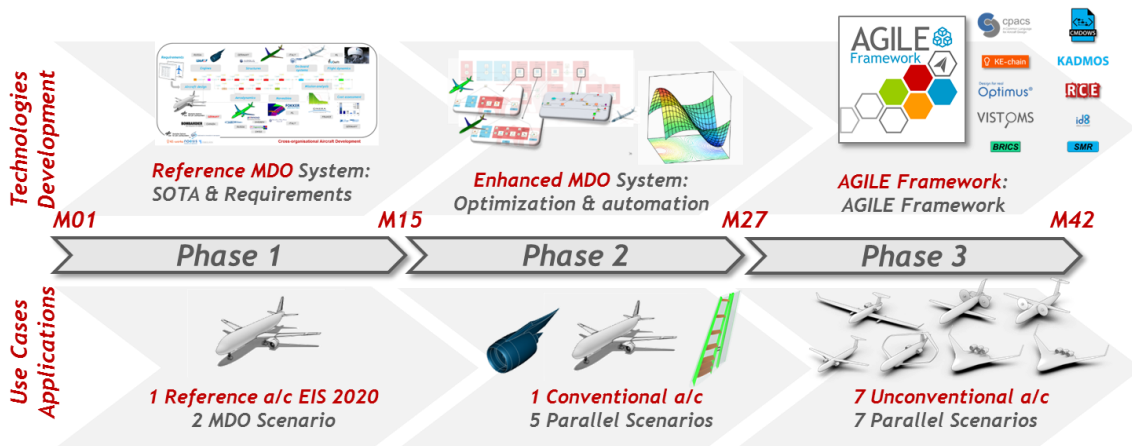

Fig. 5 Design Campaigns Roadmap. In each phase the MDO system has been advanced, as well as the complexity and number of applications

Since, the measure of the achievable improvements in aircraft performance by MDO techniques is also a function of the aircraft concept maturity, therefore the MDO applications setup in AGILE target aircraft configurations with diversified technology readiness level and estimated entry into service (EIS) in order to demonstrate the impact of the developed AGILE technologies on medium-term, and long-term aircraft products, as shown in Fig. 6.



Fig. 6 AGILE aircraft configurations selected as use-cases for MDO applications of the AGILE Paradigm

III. AGILE MDO Applications - Description

This section introduces the novel aircraft configurations selected as use-cases for the application of the AGILE Framework, and the overall approach adopted. The next Section focuses on the results.

A. AGILE Aircraft Configurations

During the phase 3 of the project (DC-3), 7 novel aircraft configurations have been developed in parallel within 15 months. For each configuration a dedicated MDO process has been formulated, deployed into a MDO system, and resolved. Fig. 7 shows the CPACS models which have been generated during the project, and dedicated MDO processes, represented by making use of the XDSM notation. A brief description follows for each configuration.

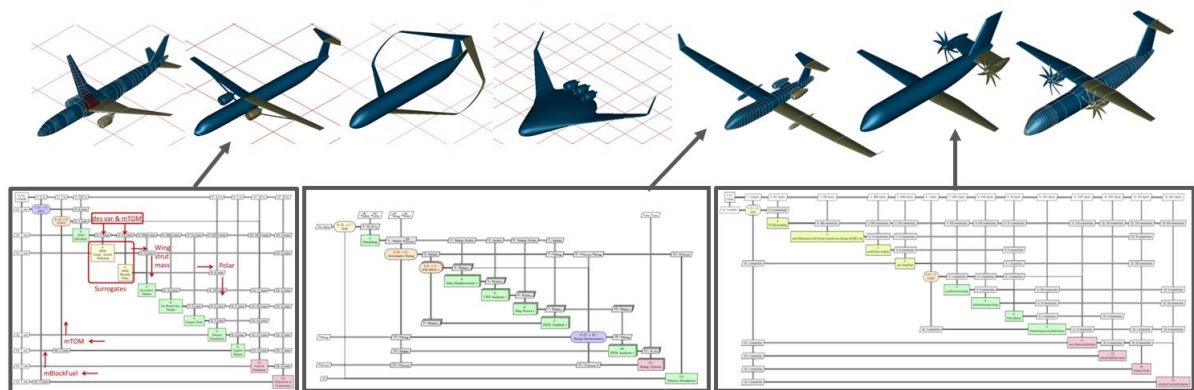

Fig. 7 AGILE configurations, from left to right: conventional large regional jet 90 pax, strut-braced wing 90 pax, box-wing 150 pax, BWB 450 pax, MALE UAV, advanced turboprop 90 pax. Top: CPACS models generated during the MDO processes. Bottom: example of dedicated MDO processes as XDSM.

Strut-braced wing aircraft

A high aspect ratio aircraft with supporting wing struts is designed and optimized, with focus on the hi-fi structural sizing based on aero-elastic tailoring. Additional analyses are included in the MDO process, as stability & control evaluation, on-board systems sizing and nacelle integration (between wing and strut). Several surrogate models are employed in place of high fidelity tools to reduce the high computational cost.

Box-wing aircraft

The study of the box-wing aircraft is mainly focused on the analyses of the flight mechanics and investigation of the stability & control and handling qualities, due to the peculiarity of the closed wing system. In particular, an intermediate fidelity model is derived for the evaluation of control derivatives, exploiting the use case for the investigation of uncertainty propagation. Moreover, a dedicated optimization approach is used for control allocation, due to the large amount of redundant movable surfaces available on the box-wing.

Blended Wing Body (BWB) aircraft

Two alternatives of BWB aircraft are studied. The former is characterized by a conventional propulsion system, i.e. with engines podded on pylons. The latter has semi-buried engines with Boundary Layer Ingestion (BLI) system. Firstly, a large Design Of Experiments (DOE) with more than 500 alternatives is executed employing low-medium fidelity tools, for a first skim among of all the possible solutions. The best ones are then analyzed by means of hi-fi aerodynamic tools. From this study, the wingleted configuration is preferred to the solution characterized by two dorsal fins. A simulator is used for the sizing of winglets and vertical surfaces, determining their dimensions in order to be compliant with stability, control and handling constraints. Afterwards, optimization strategies based on hi-fi aerodynamic tools are applied for both the configurations. It results that the second configuration might be optimal in terms of propulsion efficiency, but the extra secondary (i.e. non-propulsive) power required by the BLI system makes this solution less fuel-efficient than the configuration with podded engines.

Medium Altitude Long Endurance (MALE) Unmanned Aerial Vehicle (UAV)

The core activity of the present design case is the setup of a MDO system for the improvement of the aircraft range under certain constraints. A hi-fi aero-structural wing design process is adopted. Moreover, particular attention is posed on the preliminary design of the on-board systems, due to their high importance and relevance within this specific design case. In particular, a trade-off analysis among different solutions to de-ice the wing leading edges is conducted, as their masses and power consumption levels might be highly impacted by the long wingspan of the UAV. Eventually, a flight mechanics toolbox is employed to evaluate the flying qualities of the optimized aircraft.

Innovative turboprop aircraft

Two different configurations of innovative turboprop aircraft are investigated. The first configuration is characterized by turboprop engines mounded underneath the wings. In the second configuration, the turboprop engines are placed in the rear part of the aircraft, at the tips of the horizontal tail. Several Multidisciplinary Design Analysis and Optimization (MDAO) problems are studied, as simple converged Multidisciplinary Design Analysis (MDA), DOE and multi-objective optimization (minimization of Direct Operating Costs – DOCs – and environmental impact). In both cases, low and medium fidelity tools are used to design and optimize the aircraft, taking into account the aspects of propulsion integration

B. AGILE MDO Deployment Approach

For each of the use-cases a MDO process has been formulated and implemented and executed by making use of the AGILE Framework. All design cases have been assigned to dedicated heterogeneous teams of experts. Each team included members with the following roles:

- one **architect team**, responsible for providing the aircraft requirements (TLAR) and defining the MDAO campaigns. In all design cases, this role was assigned to one of the AGILE industrial partners
- one **integrator team**, responsible to assemble and execute the various formulated MDAO systems
- multiple **discipline specialists**, responsible for making their disciplinary tool(s) available and usable in the MDAO system, and evaluating the quality of the generated results
- one or more **collaborative engineers**, to support the integration of the various software tools (or sub-workflows) into the overall (or master) MDAO workflow

Within the AGILE Paradigm a five-step approach is used to structure this collaborative process and is referred to as the AGILE development process. Figure 2.2 shows the development process in relation to the specific technologies adopted in the AGILE Framework.

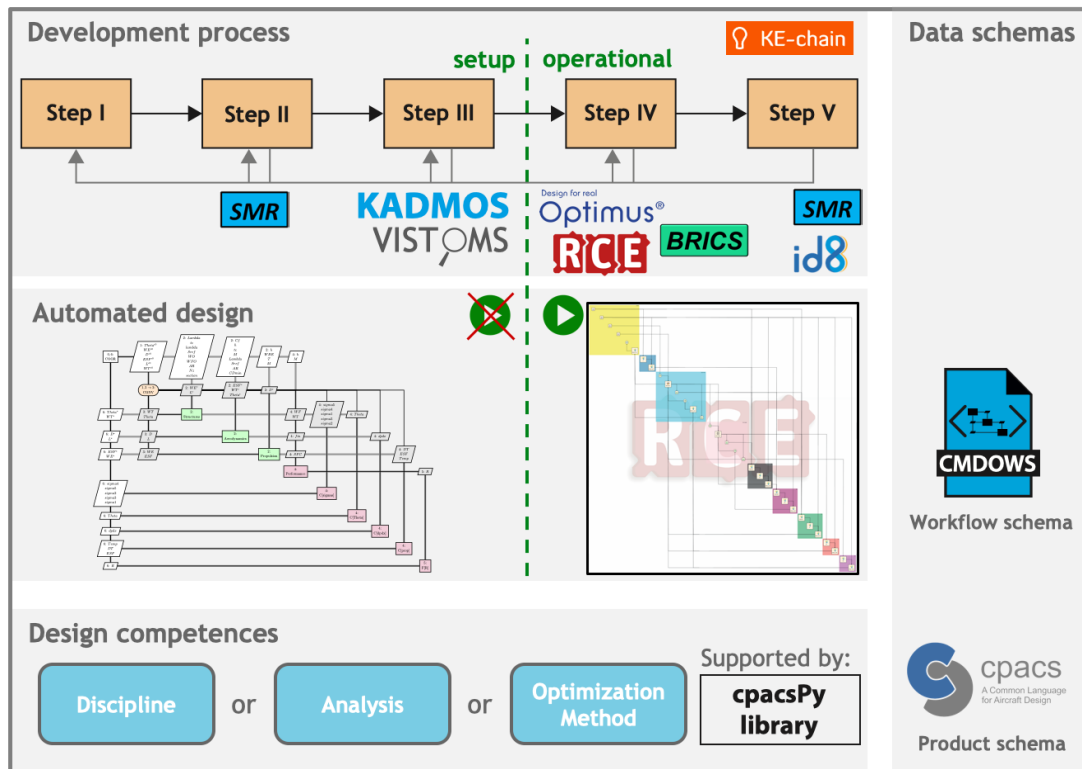

Fig. 8 Overview of interfaces and technology enablers in the AGILE Framework.

The AGILE development process provided an integrated environment, implemented in the KE-chain platform [7] as front-end, with the main function to interface with components from the automated design and design competence layer using CPACS [8] and CMDOWS [9] as data standards for aircraft products and MDO processes. The five steps and its associated technology enablers can be summarized as follows:

- **Define design case and requirements:** In the first step, information to start the design task is gathered. This includes the requirements on the design concept, required fidelity, available lead time, required analyses, available competence providers, et cetera. Next, a set of available design competences and key design parameters which need to be included in the design case are agreed upon with the discipline specialists, architect and customer(s). Key technologies: KE-chain [7].
- **Specify repository of design competences and data model:** In the second step, the collection of design competences needs to be defined. This is done by adding the required metadata (owner, creator, version, licensing information) and by mapping the inputs and outputs of the competence to the CPACS central data model (CPACSization). In addition, a so-called “base CPACS file” needs to be defined to serve as a starting point for the design analysis and to be able to verify the CPACSization of the different design competences. Key technologies: KE-chain, SMR, CPACS [8], cpacsPy library, VISTOMS [10].
- **Formulate MDO problem and solution strategy:** In the third step of the development process the design team uses the repository of design competences to first specify the MDO problem that needs to be solved and subsequently to automatically create different strategies to solve this problem. The manipulation of the repository is performed by KADMOS using graph-based analysis, while the results are dynamically visualized with the VISTOMS package. Key technologies: KE-chain, KADMOS [11], VISTOMS, CMDOWS [9].
- **Implement and execute the Automated Design workflow:** In the fourth step, the MDO solution strategy is exported as a CMDOWS file. This CMDOWS file can then be parsed in RCE or Optimus in order to get an executable workflow. Collaborative workflow execution of design competences residing on different server domains is supported by Brics. Key applications: KE-chain, Optimus [12], RCE [13], Brics [14], CMDOWS.

- **Inspect design study results:** Finally in the fifth step, the design study results from the previous step can be inspected. This requires transformation of the raw data produced by the executed MDO workflows to graphs and figures which can be interpreted by the integrator and customer. Key applications: KE-chain, ID8, SMR.

IV. AGILE MDO Applications - Results

This section contains the overall results obtained for each of the MDO use-cases introduced in the previous section. All the use-cases introduced have been formulated, deployed, and executed by following the approach described. The focus of the results here presented is on the peculiarities of the MDO workflows deployed by making use of the AGILE Framework and on the type of MDO investigations performed. Appendix contains a collection of XDSM representations of the MDO processes formulated for the use-cases and explained in the following subsections. The detailed results of the analysis performed for the design of the configurations here addressed are available in dedicated publications. Therefore, for each aircraft configuration the following points are addressed:

- Introduction use case and driving requirements
- Design and optimization process formulated and implemented
- Overview of the main results

A. Strut Braced Wing (SBW) Configuration

1. Introduction use case and driving requirements

The tight coupling between aerodynamics and structures, typical of the strut-braced wing (SBW) configuration, has been extensively investigated in literature [15], [16]. The strut relieves the wings bending-moment and allows high aspect ratio wing with small wing thickness, resulting in low induced drag and in low wave drag design. On the other hand, the strut supporting the wing creates a significant drag penalty. In FrEACs project [17] was found that the optimal solution has extremely high aspect ratio, up to 20. However, the increase of aspect ratio might be limited by the maximum span constraint which is imposed by the airport classes.

The AGILE SBW TLAR are chosen to design a configuration, which might compete in terms of transportation mission with the AGILE reference aircraft, developed during the DC-1 and the DC-2 design studies. Therefore, the AGILE SBW is a 90-seats passenger configuration, offering a mission profile comparable with the DC-1.

Table 1 AGILE SBW TLAR provided by Bombardier reports the TLAR provided by Bombardier for the configuration. The table also reports, for comparison purposes, the TLAR defined for the AGILE DC-1 reference, and for the SBW designed by DLR during the FrEACs project.

The study focuses on the challenges affecting the design of the wing-strut system. The configuration parameters driving the design process are varied and analyzed to provide a base for understanding the underlying physics of the design problem. For the strut-braced wing configuration this for example means varying the wing's aspect ratio, the span wise position of the wing-strut connection, the struts' thickness-to-chord ratio, etc.

In order to compare the designed SBW configuration with the AGILE conventional aircraft, the same driving metrics are chosen for the optimization problem. These include the minimization of Direct Operating Cost (DOC), and/or mission fuel.

The investigation performed focuses on the aero-structural aspects, addressed by different levels of fidelity and detail. Main aspects accounted in the design and optimization study are:

- **Structural static and dynamic behavior:** it is essential to quantify the benefit/penalty ratio provided by the strut.
- **Composite tailoring** of the main wing structure: composite material are expected to minimize the structural penalty provided by the strut, and offer a larger design space to satisfy the dynamic constraints
- **Aerodynamic** analysis interferences of the wing-strut-fuselage system and of the wing-nacelle-fuselage system need to be investigated. Fluid Structure interactions phenomena are addressed as well.

Table 1 AGILE SBW TLAR provided by Bombardier

Requirements	AGILE SBW HARLS	DLR FrEACs SBW
Design Range	3500 [km]	3700 [km]
Design payload	9180 [kg]	-
Max. payload	11500 [kg]	18 600 [kg]
PAX	90 pax @ 102 [kg]	154 pax
MLW (% MTOW)	90% (MLW>MZFW)	-
Long Range Cruise Mach (LRC)	0.78	0.72
Initial Climb Altitude (ICA)	11000 [m]	11000 [m]
Maximum Operating Altitude	12500 [m]	14 000 [km]
Residual climb rate	91 m/min	-
TOFL (ISA, SL, MTOW)	1500 [m]	2100 [m]
Vref (ISA, SL, MLW)	< 130 [kts]	141 [kts]
Max. operation speed Vmo / Mmo	330 KCAS / 0.82	-
Dive Mach number (Md)	0.89	-
Fuselage diameter	3 [m]	-
Fuselage length	34 [m]	-
Service life	80000 cycles	-
Fuel reserves	5% (100 nm)	-
Airport Category	ICAO C	ICAO D
A/C configuration	High-wing, T-tail, wing-mounted engines	High-wing, T-Tail, rear-mounted engines
Engine Type	Turbo Fan	CROR
On-board systems Architecture	All Electric Architecture	Conventional

2. Design and optimization process formulated and implemented

As for other use cases, the SBW design process relies on multiple design competences available at different partners. Competences range from conceptual aircraft design tools, to high fidelity simulations. Respect to the DC-1 reference aircraft, the SBW study introduces composite structures design capabilities, dynamic aeroelastic constraints (e.g. flutter), hi-fi aerodynamics for detailed analysis (e.g. wing-strut-fuselage and nacelle interactions), and hi-fi static aeroelastic analysis.

An extensive description of the SBW design process, and the deployed tools, is provided in [18], here only an outline of the process is presented. In this study converged MDA, converged DOE, and converged MDF have been generated and deployed for the analysis and optimization of the SBW configuration.

The connections among the different disciplinary competences are inspected in details and the MDA strategy is defined accordingly. For instance, the Operative Empty Mass (OEM) section, in the CPACS schema, deserves particular attention since it has to be consistently updated by several tools, namely the aeroelastic tailoring, the secondary mass estimation, and the on board system design tool. Whereas, in order to reduce the number of convergence iterations the Take-Off Mass (TOM) is updated only after the mission simulation that compute the block fuel mass. This results in a MDA with all the tools inside a converging loop except the cost and emissions calculation tool, which needs the TOM, OEM and fuel mass as input but does not update any of them. TOM is the converging variable.

The following are the steps executed in the workflow, which is shown in Fig. 9:

1. The OAD initialization tool (VAMPzero from DLR) generates the CPACS files according to the TLAR and the design variables values chosen by the optimizer.
2. The composite aeroelastic tailoring tool (PROTEUS from TUD) seizes the wing and strut primary structures.

- The flexible polar tool (AMLOAD from NLR) computes the polar taking into account the deformation of the structure according to the stiffness defined by PROTEUS.
- The secondary masses (WISE from DLR) compute the mass of the strut and wing elements not considered by PROTEUS.
- The on board system tool (ASTRID from POLITO) designs the on board systems according to the architecture defined in TLAR (all-electric aircraft, AEA, in this study), the geometry and the structural mass previously calculated.
- The mission simulation tool (FSMS from DLR) compute the fuel burn during the mission defined in TLAR, as well as the reserve fuel. This tool collects results from all the previous disciplines: the masses computed by PROTEUS, ASTRID, and the secondary masses tool; the polar from AMLOAD, and the engine performance map.
- Once the block fuel mass has been computed a script update the take of mass (TOM). If the new value of TOM is significantly different from the initial value, the entire MDA chain (from point 1 in this bullet list) is re-started with the updated TOM.
- Once convergence is reached, the service provided by RWTH estimates cost and emissions for the converged configuration.
- Finally, all the quantities of interest are collected from the data schema and made available for the optimizer or the DOE component.

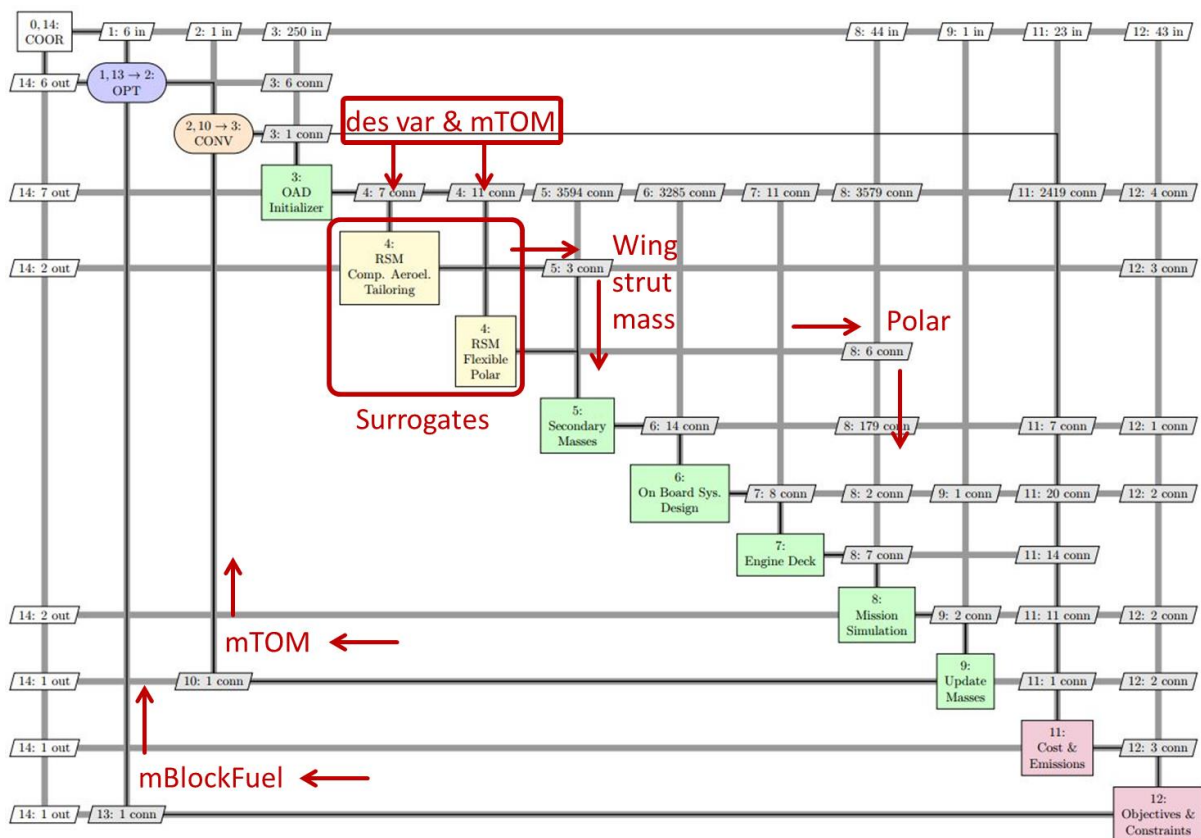

Fig. 9 XDSM of the MDF architecture for the AGILE SBW aircraft. Design competences provided by DLR, TUD, NLR, POLITO and RWTH. In this picture the block fuel mass is indicated as objective variable, but DOC has been used as well.

The optimization and the analysis processes carried out internally by the composite aeroelastic tailoring service are computationally expensive and approximately 2.5 hours are necessary to run a single analysis. In order to extensively explore the design domain and to not limit the number of converging iterations, TUD creates and deploys the surrogate of the tool PROTEUS. The definition of the surrogate's input and output (I/O) parameters highly affects the implementation of the connected tools and the overall design process.

For instance, the flexible body aero-performance analysis (AMLOAD from NLR) needs the stiffness and mass distribution defined by PROTEUS, but this information is too complex to be used as one of the surrogate outputs. Therefore, this information is implicitly assumed by the flexible aero-performance analysis, and NLR

builds the surrogate of AMLOAD as well based on the same input variables. The analyses and the tight coupling between the two disciplinary competences, as well as the surrogate building, are extensively described in [1]. An important feature of the SBW design process is the presence of the OAD initialization tool inside the MDA converging loop. At each iteration, the overall aircraft configuration is completely re-synthesized according to the same design variables but for the updated TOM value, allowing the full exploitation of the so called “snowball effect”. On the other hand, this raises challenges from the implementation point of view. According to the new value of the TOM, some topological changes may occur, like a change in the number of control surfaces.

Wing aspect ratio, wing span, sweep angle, strut-wing attachment position, wing and strut thickness to chord ratio are the design variables for the DOE study and the following optimization. A Latin Hypercube distribution with 60 points is used as DOE sampling plan.

The block fuel mass and direct operating costs are the objective variables of the optimization problem. A constraint is defined on the block fuel mass, which has to be smaller than the maximum fuel mass allowed by the wing tank volume. Another constraint is set on the flutter speed calculated by the aeroelastic tailoring tool. It has to be higher than the dive speed defined in the TLAR. Finally, a constraint on the wing loading prevents the optimizer to choose wing configuration with extremely small area, which would be critical in low speed conditions.

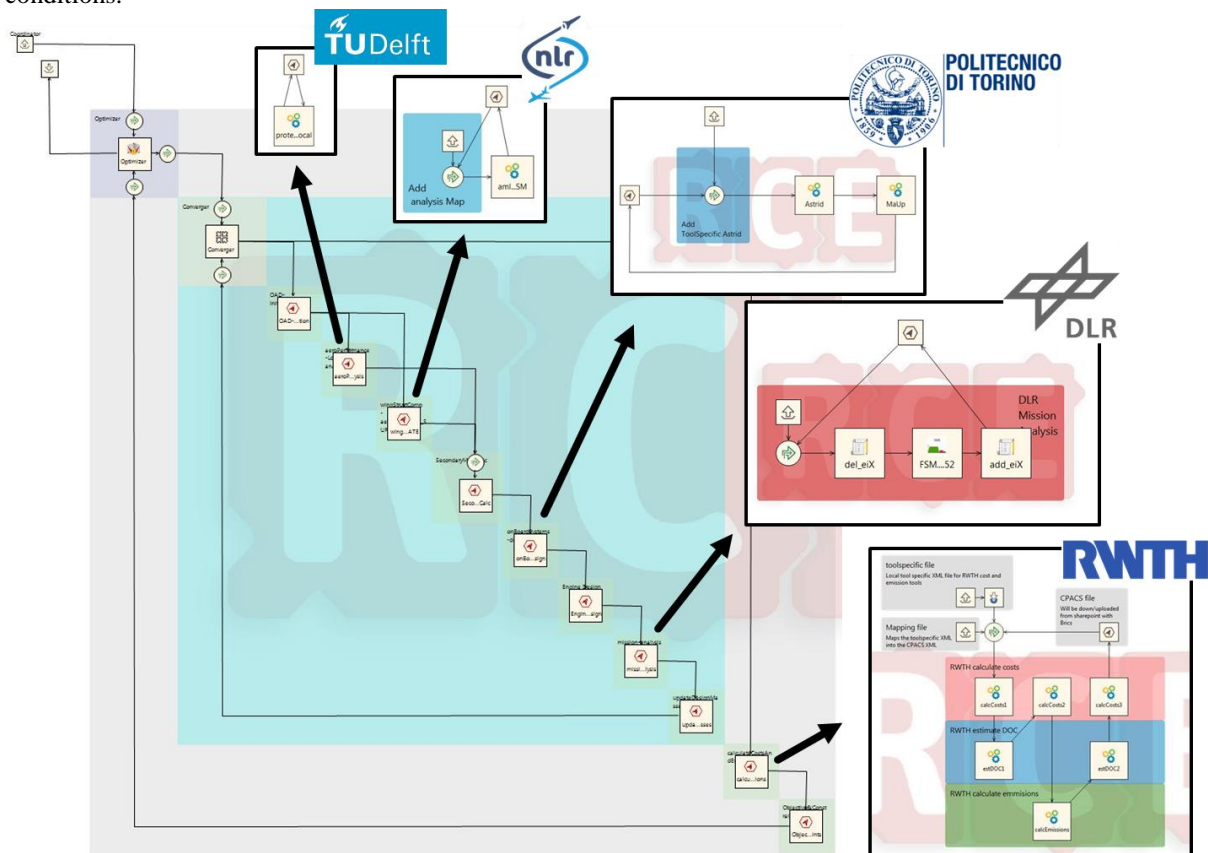

Fig. 10 Implementation of the MDF architecture as RCE workflow. Each design competency is a remote service hosted at partners’ sites, and provided to the overall workflow via Brics. On the right side some of the remote services workflows are also shown.

3. Overview of the main results

Ref. [18] provides and analyzes the full DOE study, here these results are only briefly reported, whereas the results from the MDF optimization are presented for the first time.

For each DOE point the converged multidisciplinary analysis is deployed. Since a latin hypercube is chosen as DOE strategy, a surrogate is built on the DOE outputs in order to interpret the results. Sensitivities of the quantity of interest with respect to design variables are obtained. Fig. 11 represents an example of the sensitivities analyses that have been performed. Both, block fuel mass and DOC, decrease with a decrease in span and an increase in aspect ratio. In this kind of contour plot the entire design space is represented and the values of the design variables not shown in the plot are kept equal to the baseline value (and this allows the representation of the baseline point on the contour plot).

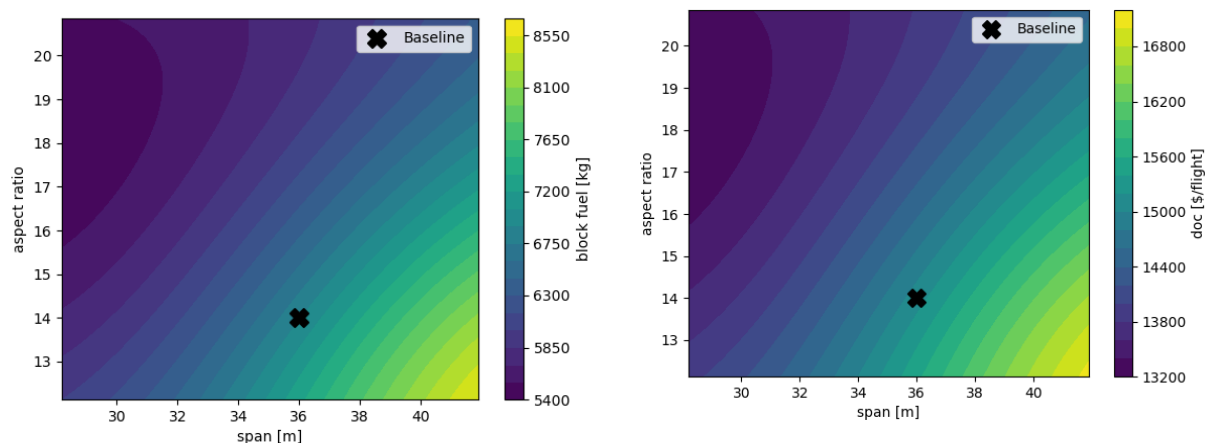

Fig. 11 block fuel mass (left) and DOC (right) contour plot with respect to span and aspect ratio.

The surrogate, built with the DOE results, is used to perform a multi-objective optimization. Block fuel mass and DOC are the objective functions. Only span and aspect ratio are used as design variables for the optimizer, whereas the other variables values are kept equal to the baseline values. Two groups of points can be identified in the pareto front associated with the lower value of DOC and block fuel mass respectively. However, for both groups the gain, in terms of block fuel or DOC reduction with respect to the baseline, is negligible compared to the surrogate reliability.

Fig. 12 shows the contour plot for the constraints. Red and blue regions represent non-admissible and admissible regions respectively. It is interesting to see that both the constraints are active in the design domain, and the maximum fuel constraint is driving the optimization. In particular the baseline as well as the pareto front are on the boundary of the admissible region and this, together with the trend represented in Fig. 11 explains the small gain of the optimized configuration with respect to the baseline.

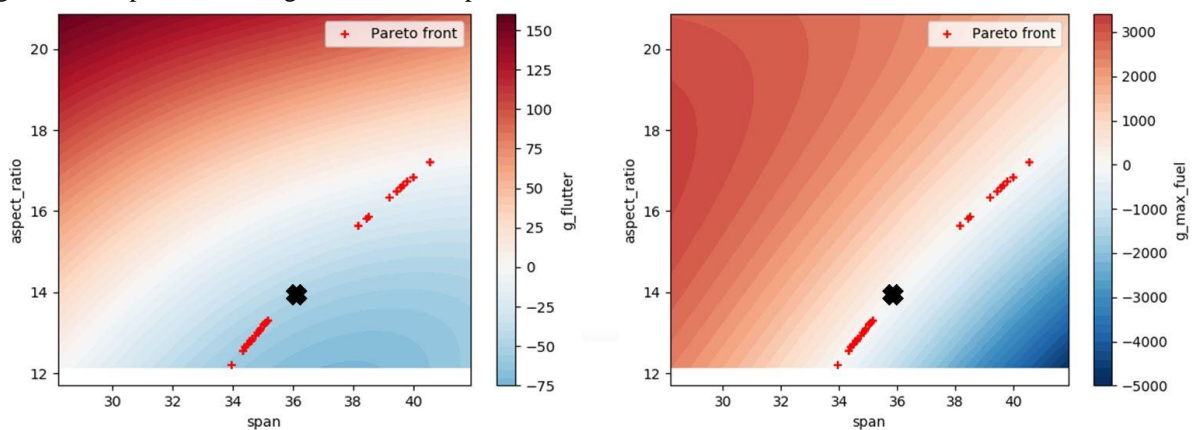

Fig. 12 flutter (left) and maximum fuel (right) contour plot using span and aspect ratio as design variables (baseline values represented by the black cross)

The trends observed in the DOE study are exploited in the setup of the optimization problem. For example, in order to speed up the process, thickness of wing and strut are not used as design variables, due to the low influence on the objective functions. Only span, aspect ratio, sweep and strut-wing attachment span position are used as design variables.

The Multi-Discipline Feasible (MDF) architecture is chosen for the multidisciplinary optimization. Two independent objective optimization problems are defined; block fuel mass and DOC are the objective of the first and second problem respectively. The same two constraints on flutter speed and maximum fuel mass are used as well as a third one on the maximum wing loading.

Table 2 MDF optimization results for the SBW configuration

Design Variables	Baseline	min Block Fuel	min DOC
Span [m]	36	33.5	33.46
Aspect Ratio	14	15.4	15.56
Sweep [°]	16	15.58	15.63
Eta Strut	0.5	0.58	0.58
Block Fuel [kg]	5681	5119	5121
DOC [\$/flight]	14051	13331	13330

Table 2 shows the optimization results. As expected from the DOE study, both minima are obtained with lower span and higher aspect ratio. Moreover, the gain in terms of both DOC and block fuel is significantly higher than the one obtained with the surrogate, and this is probably due to the higher number of design variables available for the optimizer in this second case.

Finally, it is interesting to compare this results with similar studies performed on more conventional configuration. The comparison with the AGILE turboprop optimization results, Section E, shows that the relation between DOC and span in the SBW configuration is opposite with respect to the turboprop one. However, this observation can be hardly generalized due to the different TLAR and different disciplinary tools deployed.

B. Box-Wing aircraft

1. Introduction use case and driving requirements

The box-wing configuration, in which a system of two staggered wings, joined at the tip, is applied to a quasi-conventional cylindrical fuselage, appears to offer significant advantages with respect to today's aircraft. According to Prandtl, a properly designed multiple wing system represents the ideal configuration with respect to induced drag. Furthermore, the multiple wing systems offers new opportunities for direct lift control and improved controllability. However, there are still many technical issues which need to be investigated to demonstrate the feasibility of this configuration. The aeroelastic behavior of the closed wing system is of special concern. Furthermore, good flying qualities of this aircraft should be ensured whilst preserving the prescribed lift distribution on the wings, which is necessary to achieve the low induced drag advantage. This was investigated in several studies. Finally, the (low volume) fuel tanks are distributed over the two wings, which affects the fuel system design. A list of top level aircraft requirements (TLAR) was defined for this configuration. These are presented in Table 3.

Table 3 Top Level Aircraft Requirements Box-Wing

Requirements	AGILE Box-wing
Range	3600 km
Number of passengers	150
Take-off field length	2200 m
Approach speed	138 kts
Cruise Mach number	0.78
Wing span limit	36 m
Airport compatibility	Passengers should be able to enter / exit at the gate
Engine type	Turbofan engines
Number and location of engines	Two engines mounted at the rear of the fuselage
Wing and vertical tail plane configuration	Box-wing with a low front wing and high rear wing. The rear wing is attached to two vertical tail planes
VMO / MMO	350 kts / 0.82
Time to climb to FL33	<35 min

Aircraft systems	More Electric Aircraft (MEA) configuration representative for the time frame 2035, including fuel trim system
Flight control	Enhanced control system that uses multiple redundant controls
Cruise altitude	No fixed value
Range	3600 km
Number of passengers	150
Take-off field length	2200 m
Approach speed	138 kts
Cruise Mach number	0.78

Three specific features can be observed in this list. First of all, the optimal altitude to fly from a flight performance perspective is not yet known for this configuration. Therefore, the cruise altitude is not defined in the TLARs. Second, it is foreseen that a fuel trim system is required. Third, the configuration has multiple redundant primary flight control surfaces. The main objective for the overall design would be to have minimal Direct Operating Costs (DOC). Nevertheless, an EU funded project called PARSIFAL, launched in June 2017 and including some of AGILE partners, is dedicated to this concept and is working on the overall design [19], [20]. The focus of the research in AGILE is therefore not on the overall design but on a specific aspect of the design, the analyses of the flight mechanics and investigation of the stability & control and handling qualities. In particular, the lateral stability and control characteristics (roll performance) at low altitude ($H = 1000$ m) and low speed ($Mach = 0.3$) are investigated. The inherent stability characteristics differ from a conventional aircraft due to the aerodynamics of a system of staggered wings. Furthermore, the mass distribution (inertia) of the configuration is significantly different from a conventional design. Only limited research has been done into the analysis of the stability and control characteristics of the box-wing. Especially the lateral-directional stability and control characteristics are unknown. Its potential impact on the overall design is therefore also unknown. Flying qualities requirements for roll performance at this flight condition and for this aircraft class are presented in Table 4. The roll mode time constant is a stability parameter that indicates the time it takes before a steady roll rate is achieved following a step input on the lateral stick. The time to achieve a bank angle requirement is a measure for the control power available.

Table 4 Roll Performance (lateral stability and control) Requirements Box-Wing

	Roll mode time constant (s)	Time to achieve a bank angle of 45 deg (s)
Level 1 (good)	1.4	1.9
Level 2 (adequate)	3.0	2.8
Level 3 (inadequate)	10.	3.8

2. Design and optimization process formulated and implemented

For the overall aircraft design, an MDA formulation was defined among the partners, and its XDSM is shown in Fig. 13 XDSM MDA for Box-wing. The analysis starts with the overall aircraft design tool designated INITIATOR. This tool uses both empirical and analytical methods to design and determine the characteristics of the aircraft for the mission specified by the top-level requirement. It has the ability to design and analyze conceptual aircraft of both conventional and unconventional configurations, including the box-wing. Next, some specific branches and data are added to the CPACS file. This includes an engine deck created by CIAM. With a complete CPACS file, the workflow then enters a converger loop on weights of the concept using the block fuel mass coming from the mission. As first step in the converger loop, the Maximum Take-off Mass (MTOM) is updated. Second, a low fidelity aerostructural sizing tool of the DLR is used to compute the mass of the wing and fuselage components. An aerodynamic database, including all stability and control derivatives is constructed with a Vortex Lattice Method (VLM) called TORNADO. The aerodynamic database is extended with a surrogate model of the lift drag polar based on high fidelity aerodynamic analyses which are performed offline. Following the aerodynamic analyses, the on-board systems are designed with the tool ASTRID. This includes more electric system sizing, fuel trim and power take off and bleed offtakes. Finally, a mission simulation is performed with the FSMS tool provided by the DLR. Once the design is converged, the stability and control characteristics can be computed and costs and emissions are estimated.

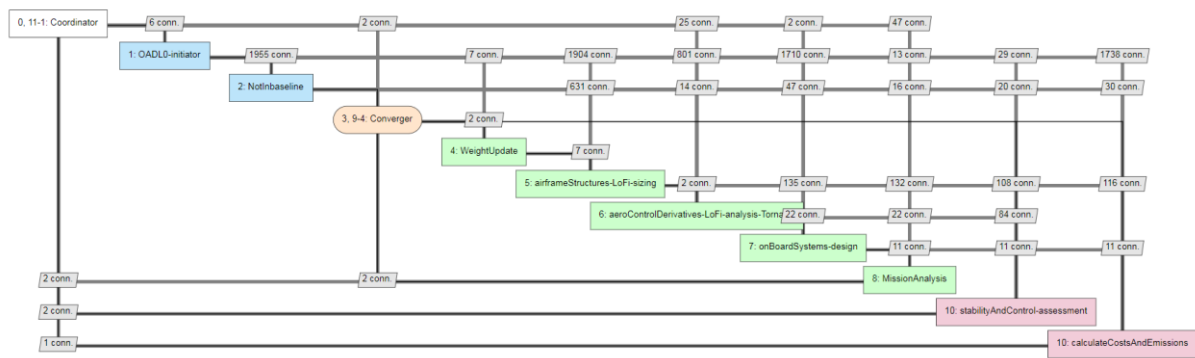

Fig. 13 XDSM MDA for Box-wing

In addition to this MDA workflow for the overall configuration, an optimization problem was set up using a limited number of analysis tools and focusing on lateral stability and control aspects (roll performance), one of the key challenges of the box wing concept. The objective is to solve a weight minimization problem under flying qualities constraints, with uncertainty on mass and mass distribution, thus leading to solve an Optimal Reliable Design Problem (RBDO). The selected design variables are related to the geometry of the wing (aspect ratio and sweep) and the geometry of the primary flight control surfaces (control surface span). The overall structure of this optimization problem is presented in Fig. 14 XDSM view for the lateral stability and control workflow..

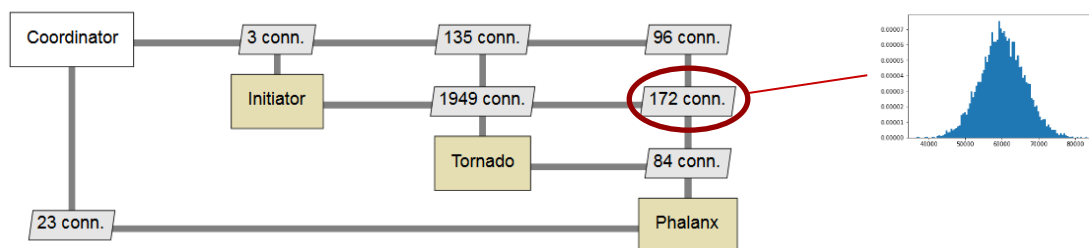

Fig. 14 XDSM view for the lateral stability and control workflow.

The advantage of this approach is the lack of feedback coupling between different design competences. The main drawback of this approach is the high level of uncertainty on the aircraft mass and the mass distribution (inertias) since there is only a low fidelity (L0) OAD tool in the loop. Therefore, without higher fidelity tools in the workflow, the weights and inertias values will not be refined. To consider this uncertainty, Gaussian laws were created for MTOM and the mass inertia matrix, taking into account the specialists 'feedback. The coupling variables are now random ones and these uncertainties on the mass and inertia propagate through the workflow. This means that, ultimately, uncertainties on the roll performance are computed.

The time-to-run for each of these design competences is an important element because this can drive the choice for the best approach: here, the Initiator takes approximately 30-50 minutes, Tornado requires in the order of 40-50 min and Phalanx only needs about 2 minutes

3. Overview of the main results

The focus of the research is on the stability and control characteristics. For the overall aircraft design workflow, only example results for the on-board system design are presented. The fuel trim system is indicated in Fig. 15 and results for the baseline configuration are shown in Fig. 16. On the left hand side of Fig. 16, the weight breakdown of the selected on-board systems architecture is presented. Due to the choice for a More Electric Aircraft, one can observe a relatively high level of electric systems weight comparable to the ECS weight for instance as well as the absence of hydraulic systems. On the right hand side, the mechanical power off takes on each engine are presented for the main mission phases.

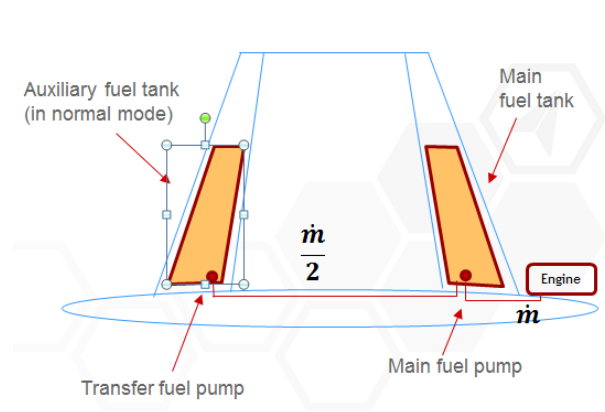

Fig. 15 Fuel trim system

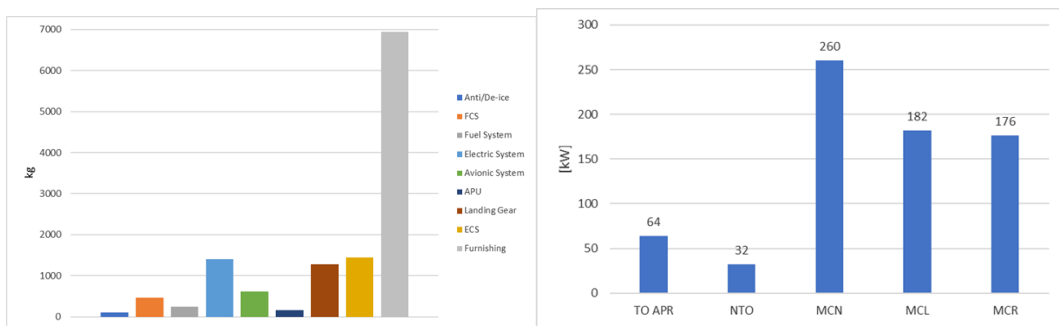

Fig. 16 Example analysis results for the on-board systems for the AGILE Box-wing.

Next, the results obtained with the stability and control design study are presented. As a starting point, an example simulation result with Phalanx is presented in Fig. 17. On the right hand side, the outside view of the flight simulation is presented. On the left, the time history of a lateral stick step input is presented. The step input starts at 1 second into the simulation. Next, the roll rate builds up. The steady roll rate is approximately 34 deg/s. Since the stick is at its maximum deflection, this represents the maximum roll performance. After 1.1 seconds, 63.2% of the steady roll rate is achieved. Therefore, the roll mode time constant is 1.1 seconds. A bank angle of 45 degrees is obtained 2.19 seconds after initiation of the maneuver. This means that for this specific design, the roll mode time constant parameter is level 1 (good) and the time to achieve a bank angle of 45 degrees represents level 2 (adequate) flying qualities. This type of simulation can be done for any design.

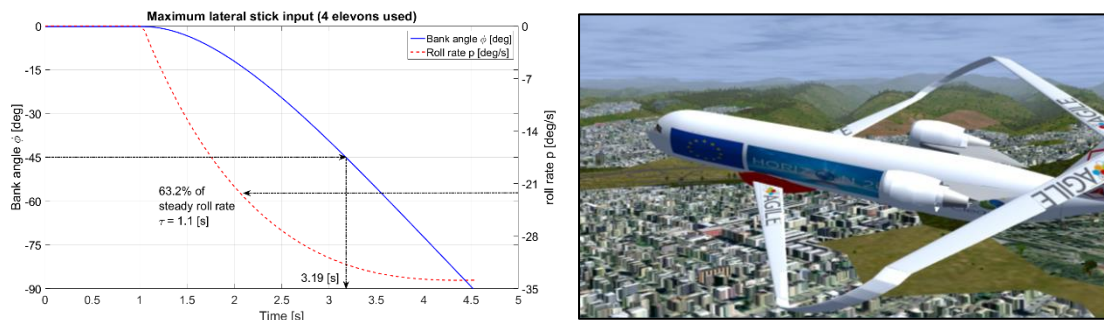

Fig. 17 Example simulation result Phalanx (stability and control)

Three separate design problems were analyzed:

Problem 1

- The objective function is a composite function of OEM and M_{Fuel} computed by the Initiator
- Design variables are wing aspect ratio and wing sweep, in a range $\pm 5\%$ around the nominal design
- The time to achieve a bank angle of 45 deg and the roll mode time constant are probabilistic constraints

Problem 2

- The objective function is a composite function of OEM and M_{Fuel} computed by by Initiator
- Design variables are wing aspect ratio, wing sweep, and the control surface size (η – location of control surface inner edge)
- The time to achieve a bank angle of 45 deg and the roll mode time constant are probabilistic constraints.

Problem 3

- The objective function is a composite function of OEM and M_{Fuel} computed by the Initiator and a maximization of probability of level 1 roll performance.
- Design variables are wing aspect ratio and wing sweep,

The rationale for developing problems 2 and 3 was the following. The second problem was developed considering that in Problem 1, the configurations had usually “good” time to bank angle of 45 deg (closer to level 1 than level 2). As this constraint is closely related to the position and size of the primary control surfaces, functioning as ailerons, it was decided to add a new variable in the problem: the span of these control surfaces. A reduction of this span will lead to a degradation of the “*time to bank angle of 45 deg*” constraint while decreasing the OEM of the aircraft. The reduction of OEM (due to structural and OBS weight reduction) was taken into account through the addition of a dedicated script in the workflow. For Problem 3, the idea was to go for level 1 characteristics for both constraints. The idea was to maximize the number of configurations having both good objectives functions and high probability to be level 1 for both roll performances. The probabilities are therefore included in the objective function.

Nevertheless, one of the difficulties of the approach is to estimate accurately enough the probability of “failure” of the configuration regarding the flying qualities, that is to say the probability of the roll performances to be higher than a fixed limit (level 2 for instance) in function of the uncertainties on MTOM and inertias.

As the targeted probabilities are expected to be quite low, it was decided to use AK-MCS algorithm (for Active learning reliability method combining Kriging and Monte Carlo Simulation). The advantage of the method is that it needs a limited number of calls to a model to estimate the probability of failure with an acceptable accuracy.

All three problems were ran using ONERA’s SEGOMOE optimizer [21], [22] which has the advantage to start with a DOE and that has also proven its capability for finding good candidates in a limited computational budget. Execution was run using the RCE platform and all the executions were made through Brics multi-task, even for the AKMCS competence, hosted on the same machine of the overall workflow. For each iteration of the Optimizer, Phalanx competence was called between 12 and 100 times to estimate accurately the probabilities required to assess the constraints values. The main results are summarized in Table 5. The best configuration produced by each optimization problem is compared to the baseline aircraft configuration.

Table 5 Results of design optimization with a focus on Box-wing stability and control characteristics

Configuration	Variables			Objective: 0.5 OEM + 0.5 M_{fuel} [kg]	Roll mode time constant		Time to achieve a bank angle of 45 deg.	
	Sweep [deg]	AR [-]	η [-]		Probability Level 1 [%]	Probability Level 2 [%]	Probability Level 1 [%]	Probability Level 2 [%]
Baseline	37.5	7.5	0.82	22172	0	0.7	100	100
Problem 1	35.8	6.91	0.82	21166	-	100	-	100
Problem 2	35.8	6.75	0.85	20982	-	100	-	100
Problem 3	35.3	6.99	0.82	21265	97.948	-	95.289	-

It can be concluded that all three new aircraft configurations exhibit better performance in terms of weight or handling qualities than the reference aircraft. With this approach, relying on OAD tool, the objective was to quickly identify areas in the design space where robust designs can be found (regarding handling qualities) and helped to reduce the design step when increasing the fidelity of the design competences.

C. Blended Wing Body (BWB) aircraft

1. Introduction use case and driving requirements

Blended Wing Body is a highly integrated unconventional aircraft configuration with potential benefits of aerodynamic efficiency and weight fraction efficiency. In order to evaluate its behaviour high-fidelity analysis are necessary. In AGILE the BWB configuration is in two variants, shown in Fig. 18: the first with conventional podded engine, and the second with an integrated airframe-nacelle design and including a Boundary Layer Ingestion (BLI) system. The Top Level Aircraft Requirement for the AGILE BWB are reported in Table 6 and are the same for both the variants. Therefore, the AGILE BWB MDO problem focuses on the optimization of the BWB shape and the stability & control aspects (for the podded engine variant), and on the integration of the propulsion system (for the BLI variant). Detailed method and result can be found in [23].

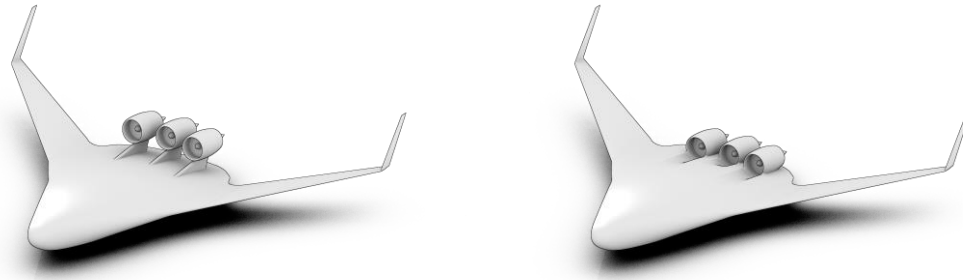

Fig. 18 AGILE BWB variants: podded engine (left), BLI (right)

Table 6 TLAR– BWB aircraft

Category	Name	Unit	Description	Cond	BWB
payload range	Pax	[-]	number of passengers	=	450
	m _{payload max}	[t]	maximum payload	=	59
	range	[nm]	maximum range @ m _{payload max}	>	8500
performance targets	M	[-]	Mach number in cruise at ICA	=	0.85
	H _{max}	[ft]	maximum operating altitude	>	43000
	V _{appr}	[kts]	approach speed (@MLW, SL, ISA)	<	166
airport compatibility	TOFL	[m]	take-off field length (@MTOW, SL, ISA + 15deg)	<	2950

2. Design and optimization process formulated and implemented

The MDA process concept formulated for the BLI variant is presented in Figure 6 5, and the corresponding steps are explained in the following:

1. Preliminary Design Space Exploration (DSE) is performed at DLR and initial geometry is generated.
2. The engine thrust requirements, preliminary weight and drag is also estimated as a feasible starting point.
3. The baseline geometry is transferred via secure BRICS network to University of Naples for HiFi CAD geometry creation (A requirement for RANS based aerodynamics analysis)
4. In this step multiple partners such as University of Naples, CFSE, TsAGI perform aerodynamics analysis, with comparison between each tools and level of fidelity.
 - a. In step 4a, which is the main focus of the BLI variant, Politecnico di Torino and TsAGI design the Boundary Layer Ingestion system.
 - b. Politecnico di Torino evaluates on-board system mass and power consumption based on the preliminary aircraft weight and performance, including the BLI system designed in step 4. The mission profile and specification are considered for power consumption of on-board system.
5. CIAM provides engine performance maps for the required thrust and offtake, taking into account the BLI system performance.
6. Structural mass of BWB is evaluated with preliminary analysis.

7. Based on engine thrust parameter and on-board system offtakes, Nacelle is designed by TsAGI. The designed Nacelle is integrated with the BLI to airframe with Hi-Fi aerodynamic analysis. Total aircraft aerodynamics with integrated nacelle and BLI is evaluated in this step. In first phase the cruise regime is checked.
8. Data fusion of all Hi-Fi aerodynamic, structural, on-board system and propulsion analysis is made by TsAGI and the Aircraft data file is prepared for mission simulation
9. In this step DLR's mission simulation module flies the aircraft as per the mission profile of TLAR. The fuel consumption is estimated, weights updated. If any redesign of the BLI system is necessary, the steps from 1-8 are repeated
10. The converged aircraft is tested for stability and handling qualities by TU Delft
11. Emissions and costs are assessed by RWTH at this step

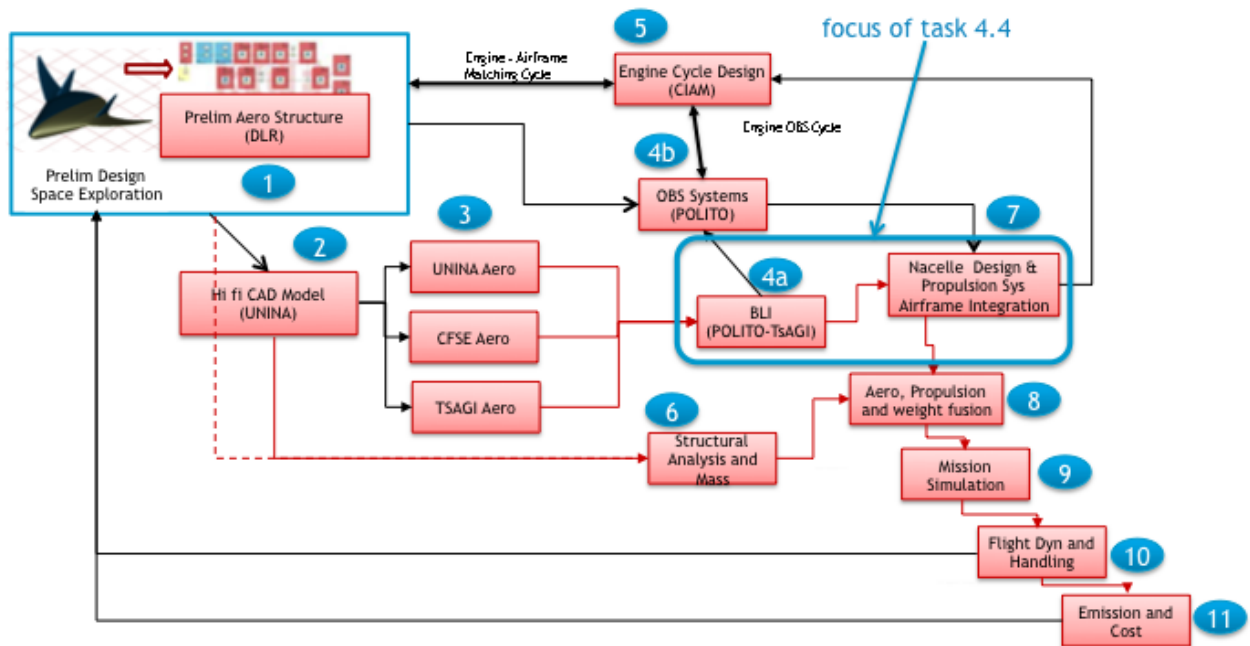

Fig. 19 Preliminary process formulation for BWB with BLI system

A MDA formulation is selected for the optimization strategy, and represented as XDMS diagram in Fig. 20.

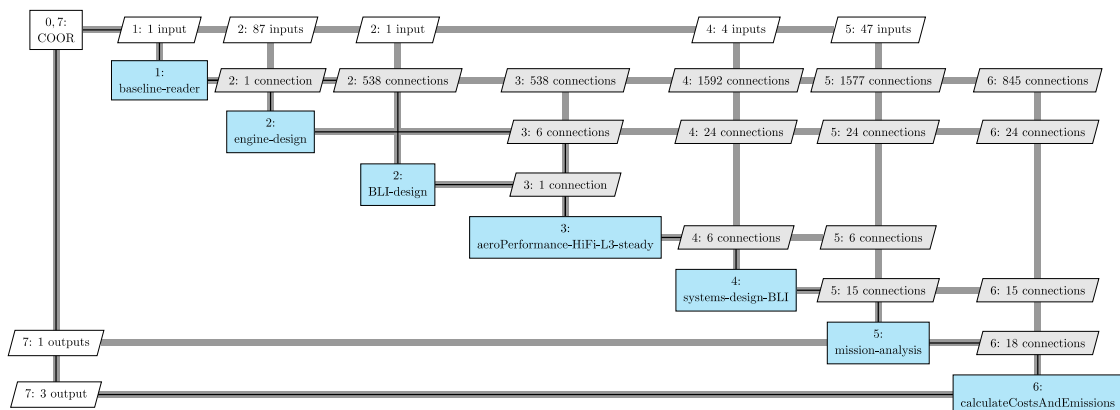

Fig. 20 XDMS graph for MDA formulation in use case BWB

With respect to the described process, the BWB with the podded engine variant does not include the BLI design and the nacelle-airframe integration and shape design, however explore more extensively the flight dynamics aspects. Furthermore, due to the complexity of some performed analysis involved and the variation of investigations performed (e.g. high-fidelity aerodynamics shape optimization, flight dynamics and control design, and BLI integration), the basic MDA has been re-configured in multiple variants, each leading to an ad-hoc workflow. It is not in the scope of this paper to show all the variants workflows obtained, but details of the

studies performed can be found in [23]. Fig. 21 shows example of the aerodynamic analysis carried on both the BWB variants.

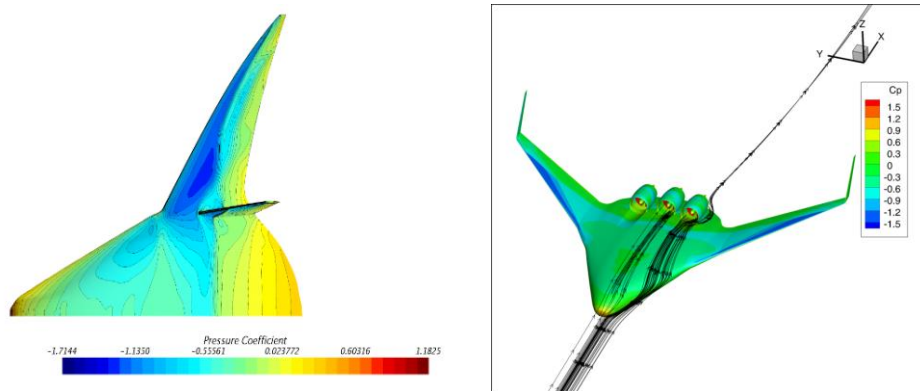

Fig. 21 Example of aerodynamics analysis performed. BWB baseline by University of Naples (left). BWB with integrated nacelle by CFSE (right).

3. Overview of the main results

Due to the large amount of analysis and DOE executed only a selection of the studies performed is here reported as representative for the BWB final configuration variants, namely:

1. Flight dynamics & control aspects (BWB podded engine)
2. BLI system design (BWB BLI)

Flight dynamics & control aspects (AGILE BWB podded engine variant)

The longitudinal flying qualities of the BWB are analysed using the Performance, Handling Qualities and Loads Analysis Toolbox (PHALANX) by TU Delft, which serves as virtual flight test within MDO frameworks. The flight dynamics simulation model is nonlinear with six degrees of freedom. Ten flight multifunctional flight control surfaces are defined at the trailing edge of the BWB. Two different control allocation schemes are implemented in the simulation model to distribute the three pilot commands over the ten control surfaces. These schemes are the Daisy Chain method and the Weighted Pseudo Inverse (WPI) method. The flight control system model includes second order actuator dynamics and actuator rate and saturation limits. The propulsion system is represented with look-up tables (engine decks provided by CIAM) as function of Mach number, altitude and throttle setting.

The trim control angles and the associated angles of attack are displayed in Fig. 22 for the baseline BWB. It can be observed that the aircraft is approximately neutrally stable for a c.g. position of 23.5 m at low speed flight. With a small static margin, trim control angles have a reasonable margin from the limits. Simulations with a larger static margin result in significantly larger control deflections. Furthermore, the results show that due to the high weight of the aircraft, a large angle of attack is already obtained at 110 m/s true airspeed. The same trim analysis was performed for the BWB with embedded engines. This analysis reveals that the magnitude of the trim control deflections at low speed can be reduced by approximately 2 degrees due to a lower thrust line. Hence, the control margin is slightly improved by embedding the engines.

Thereafter, the characteristics of the phugoid mode, the short period mode and Control Anticipation Parameter (CAP) are assessed with the flight dynamics simulation model. Results for the short period and control anticipation parameter are summarized in Fig. 23. The handling qualities levels indicated are for Class III aircraft in category B and C flight phases [5.31]. For nearly all airspeeds and c.g. and weight combinations, the predicted handling qualities are in the level 1 region. Only for the cruise condition and low weight, the predicted handling qualities degrade to level 2. The predicted handling qualities for the phugoid mode are level 1 both for cruise flight and low speed and for all weight and c.g. combinations. Details are reported in [23].

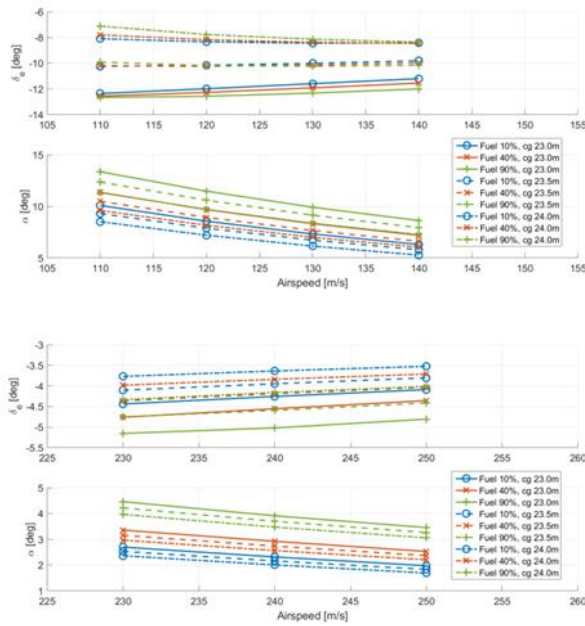

Fig. 22 Trim control angles and angle of attack at low speed, low altitude (above) and cruise (below) for the baseline BWB

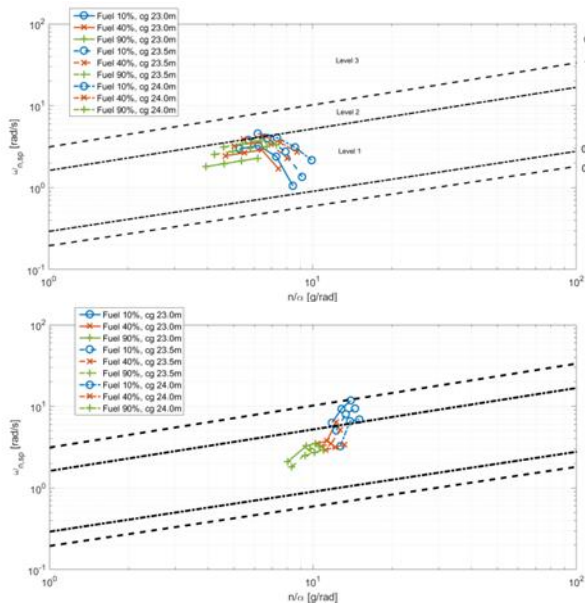

Fig. 23 Short period and control anticipation parameter at low speed (top) and cruise flight (bottom)

BLI system design (AGILE BWB BLI variant)

Regarding the BLI design for the AGILE BWB an active system to reduce the distortion and the drop of pressure recovery due to boundary layer ingestion (BLI) is proposed. The Active Flow Control Systems (AFCS), representing one of the several solutions, has been calculated both in terms of mass and power needs integrating it with the other systems. The AFCS uses distributed control jets of pressurized air to spread the boundary layer around the circumference of the diffuser reducing the inlet air distortion. In place of or with AFCS, the vortex generators (VGs) installed in the diffuser are used. A proposed system architecture providing active flow control is shown in Fig. 24. The rarefied external air is firstly compressed by means of one or more NACA air inlet. The NACA air inlet is not sufficient to reach the necessary pressure for the air jet and the system should also operate with an aircraft speed closer to zero. For these reasons, a series of centrifugal compressors driven by electric motors are considered. To easy the compressors installation, hence to reduce their diameter, it is selected an architecture of three double stages compressors. Finally, the compressed air is delivered to AFCS controller that defines the best strategy of distortion reduction controlling the airflow through the air jets.

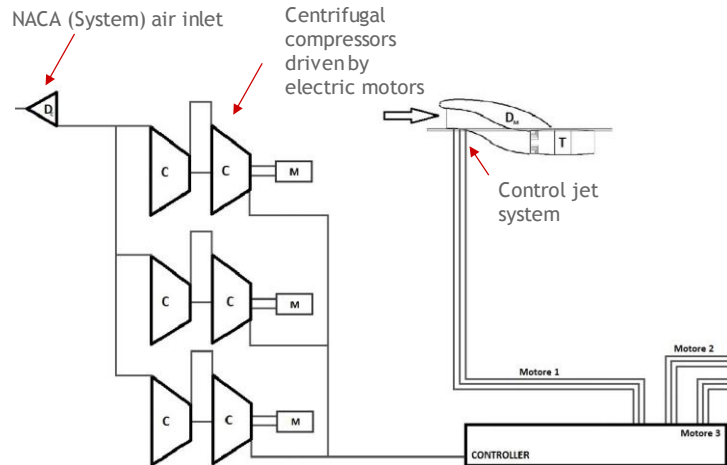

Fig. 24 On-board Systems architecture providing Active Flow Control Systems reducing inlet flow distortion.

With the aim to design in a preliminary way the AFCS, a possible mass and power required are estimated. The objective is to calculate an order-of-magnitude values to consider also the drawbacks of this solution together with the advantage of drag reduction. Starting from the results obtained for BWB standard, the mass and power demand of AFCS are added obtaining the results shown in Table 7 and Fig. 25. Since the AFCS can be considered an additional electric system consumer, the electric system has been upgraded to supply more power, and therefore increasing its mass with respect to a non BLI variant. Details are reported in [24], [25] [26].

Table 7 Mass breakdown of the on-board systems for BWB aircraft with BLI

OBS	Mass [kg]
Avionics	617
FCS	784
Landing gear	9268
ECS and IPS	2339
Fuel system	409
APU	772
Furnishing	16622
<i>HPGDS</i>	0
<i>EPGDS</i>	4580
<i>BLI system</i>	1300
Total Systems Mass	36691

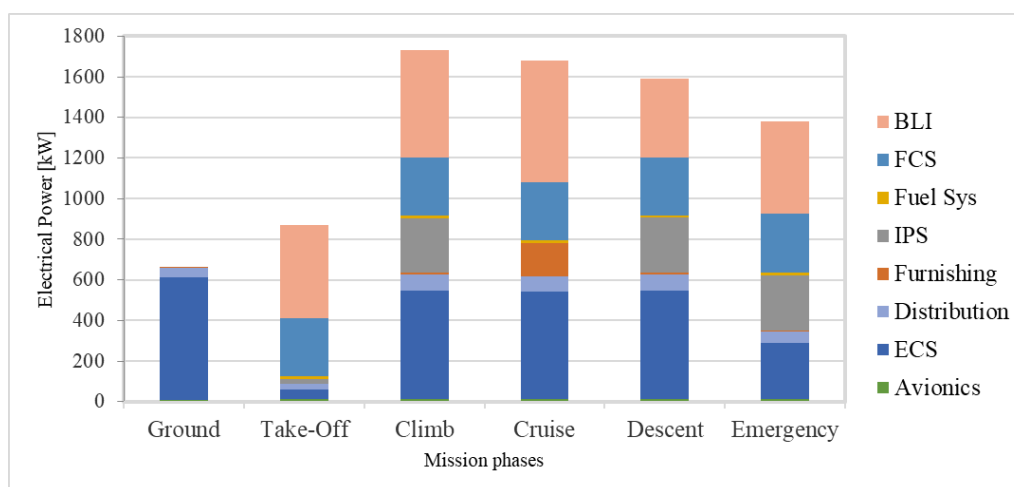

Fig. 25 On-board system power offtakes calculated for each segment of the mission profile.

D. Medium Altitude Long Endurance (MALE) UAV

1. Introduction use case and driving requirements

The baseline of the present design study is the *OptiMALE* aircraft from the German research project AeroStruct [27]. This concept is a medium altitude, long endurance unmanned aerial vehicle (MALE UAV). The Top Level Aircraft Requirements (TLAR) of the concept are defined by Airbus Defence and Space and iterated with Leonardo Company and are listed in Table 8.

Table 8 AGILE MALE UAV TLAR provided by Airbus Defence and Space

Requirements	AGILE MALE UAV
Cruise above civil transport	>15 [km]
Range	>12000 [km]
Runway length	2500 [m]
Cruise speed	150 [m/s]
Dive speed	180 [m/s]
Landing speed	55 [m/s]
Payload weight	800 [kg]
Payload volume	4 [m ³]
Payload power consumption	10 [kW]
2 external fuel tanks	
Electric powered hydraulic system	
SatCom Communication system	
SEP @ 6 [km]	160[m/min]
SEP @ 15 [km]	50[m/min]
SEP @ 18 [km]	0[m/min]
Roll Rate	60 [deg/s]
Sink Rate	40 [m/s]
Climb Rate	160 [m/min]

Two reference missions were defined for the MALE UAV aircraft: One transfer and one surveillance mission. The latter is described in Table 9, because it was chosen as optimization reference mission. The objective here is a maximum endurance by altering the wing shape and the structural wing weight. The main constraints are the structural strength and stability of the wing.

Table 9 Surveillance mission definition

Mission Segments	
Start	-
Climb	>FL 500
Cruise flight	>1000km @ FL 550
Loitering with 1.05 g @ FL 200-450	> 20 h
Cruise flight	>1000km @ FL 550
Descent	-

2. Design and optimization process formulated and implemented

An initial phase consisted in the deployment of a preliminary MDA, comprising the initial design synthesis by Airbus Defence and Space, the definition of the on-board system architecture by Politecnico Torino, the design of the engine deck by CIAM, the analysis of the handling characteristics by TU Delft and the mission performance analysis by the DLR. Thereafter, the output of the preliminary design was forward to a converged MDA for the aeroelastic shape optimization and sizing process, relying of high-fidelity design competences. A schematic representation of the two processes is illustrated in Fig. 26.

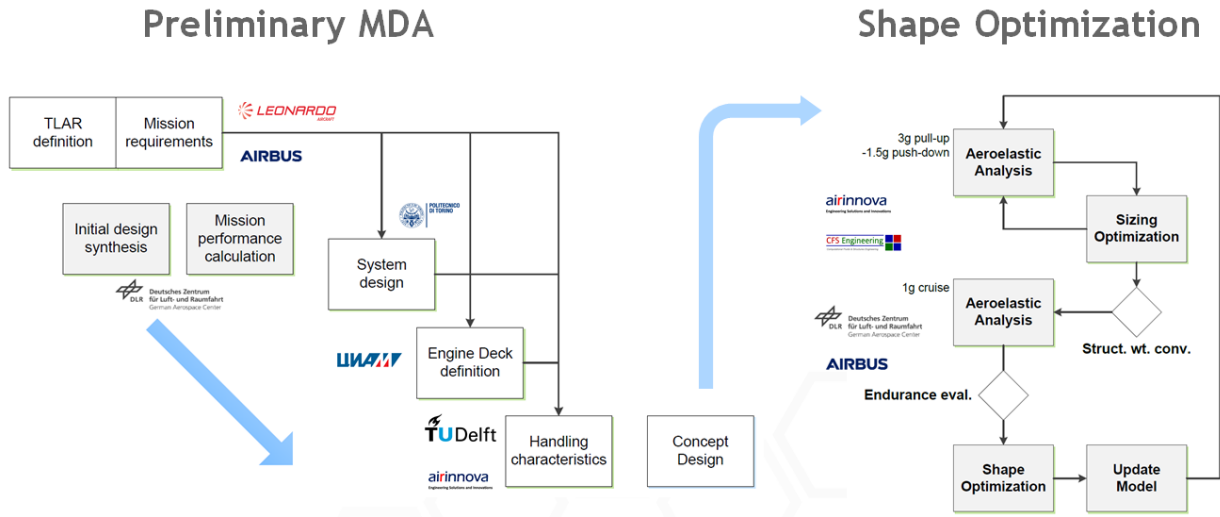

Fig. 26 Schematic of the preliminary design MDA and hi-fi aeroelastic shape optimization and sizing.

The high-fidelity workflow deployed consisted mainly of a DOE wrapping a converged MDA for of the aeroelastic shape optimization. Fig. 27 shows the extended design structure matrix (XDSM) representation of the process implemented and consists mainly of three nested loops: an aeroelastic analysis loop for loads analysis, an airframe structural sizing optimization loop and a wing shape optimization loop.

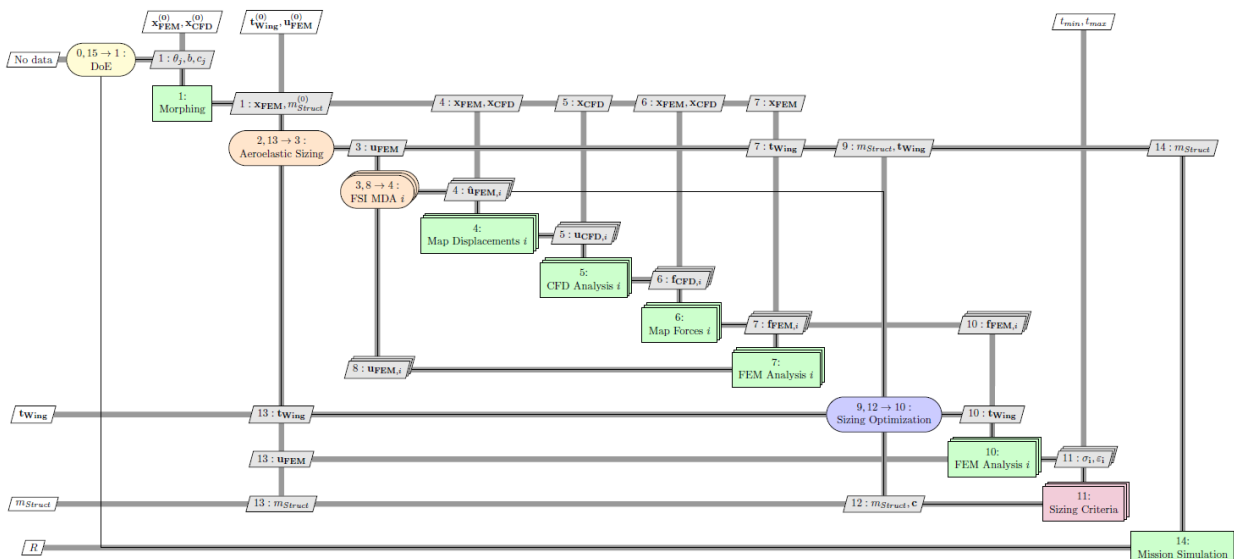

Fig. 27 XDSM AGILE MALE UAV high-fidelity design workflow

The collaborative MDO workflow is centered around the MDA loop, where the aeroelastic equilibrium between structural deformation and aerodynamic forces is computed in an iterative process employing a Gauss-Seidel fixed-point iteration scheme on the structural deformation.

Following points have to be emphasized for the here developed workflow.

- The external shape and the structural sizing will be both optimized considering the aeroelastic coupling
- The maximum and the minimum load-factors define the design points for the structural optimization.

- The cruise flight condition provides is the design point for the outer shape optimization.

The aeroelastic loop, shown in Fig. 28 is at the core of this process. The analysis is initialized with an undeformed aerodynamic model and an unloaded structural model. An initial set of deformations of the structural mesh is mapped onto the aerodynamic surface mesh points by using a method implemented by DLR [28]. Conveniently, it is sufficient to compute a mapping matrix once at the beginning of the aeroelastic sizing process, since only the displacements are adapted, while the underlying meshes remain unchanged. The mapped results are passed to CFSE or AIRINNOVA, who are responsible for performing the aerodynamic analysis, where they are taken as inputs for the volume mesh deformation. In order to alleviate configuration effects between wing and empennage, only the wing deformations are taken into account so far. The pressure distribution on the surface cells, resulting from the subsequent Euler analysis, is then post-processed into force vectors acting on the individual mesh points. The force vector distribution on the aerodynamic surface points is returned to the parent workflow and mapped back onto the structural model using. The process is iterative and provides a converged aeroelastic load-case. Therefore, the resulting forces are used in the next step, for the structural sizing optimization. Here, the optimal thickness distribution for minimum structural mass are computed, while maintaining structural strength and stability constraints. This modifies the stiffness of the structure, therefore the aeroelastic loop must be repeated. After the structural mass is converged, the endurance of the actual configuration needs to be evaluated with an aeroelastic calculation in cruise condition. In the shape optimization loop (outer-most loop), the geometry of the wing is updated and the analysis models are morphed thereafter. The structural sizing optimization is mainly a functionality of the internal Airbus DS software *Lagrange* [29].

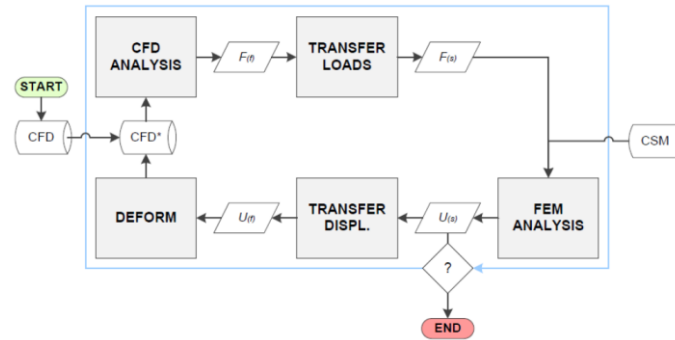

Fig. 28 Aeroelastic Loop

The objective function is to minimize the structural weight by altering the thicknesses and areas of the finite element properties. The optimization is constrained by stress, strain and stability allowables with safety factors applied. The optimization is then started with a converged set of forces from the aeroelastic loop. After the structural sizing optimization converged with minimal structural weight, the stiffness of the aircraft has changed and this invalidates the initial aeroelastic load-case. Therefore, the aeroelastic loop is repeated with updated structural model, and the converged set of forces from the last aeroelastic loop is taken as a starting point.

$$E = TSFC^{-1} \frac{L}{D} \ln \frac{MTOW}{MZFW} \quad (3)$$

TSFC Thrust specific fuel consumption
 MTOW Maximum takeoff weight
 MZFW Maximum zero fuel weight

Equation 1 Endurance

After convergence of the structural mass is achieved, an evaluation of the endurance has to be performed with Equation 1. The actual $\frac{L}{D}$ ratio is taken from another run of the aeroelastic loop in cruise flight condition and the actual fuel weight fraction can be calculated with the MTOW kept constant and the converged structural weight from the second sizing optimization step. The target function for the shape optimization is to maximize the endurance value. With a set of geometric design variables of the main wing e.g. the span, the chord or the aspect ratio, the lift to drag ratio can be increased directly or the MZFW can be decreased indirectly. After the geometric shape design variables are updated by the optimizer, they have to be propagated to the analysis models as well. This is the task of the internal Airbus DS tool *Descartes* by morphing the FEM model. The structural mesh is kept constant with respect to the number of elements and nodes, and their connectivity is preserved. Only the coordinates of the grid points are changed. The aerodynamic mesh is based on a different geometry, so it was decided to reuse the mapping method from the aeroelastic loop by applying a structural shape change to the aerodynamic model, as it would be a displacement value. Enabling process automation is a

major topic of the AGILE project. The inner aeroelastic loop is automated via Brics and RCE in the following steps by CFSE as shown in Fig. 29 and Fig. 30.

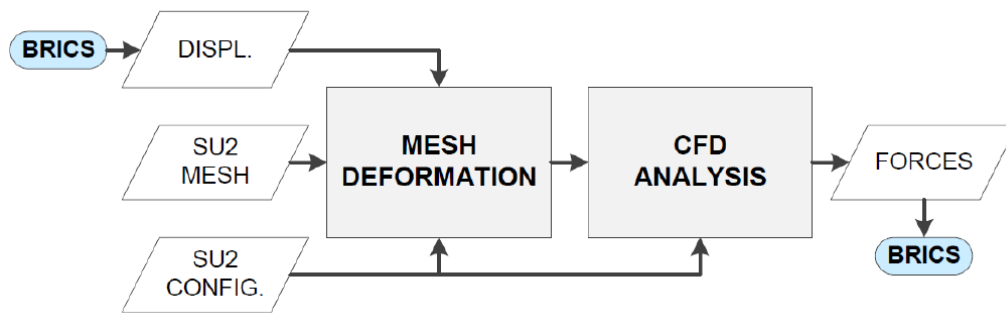

Fig. 29 Automated aeroelastic process

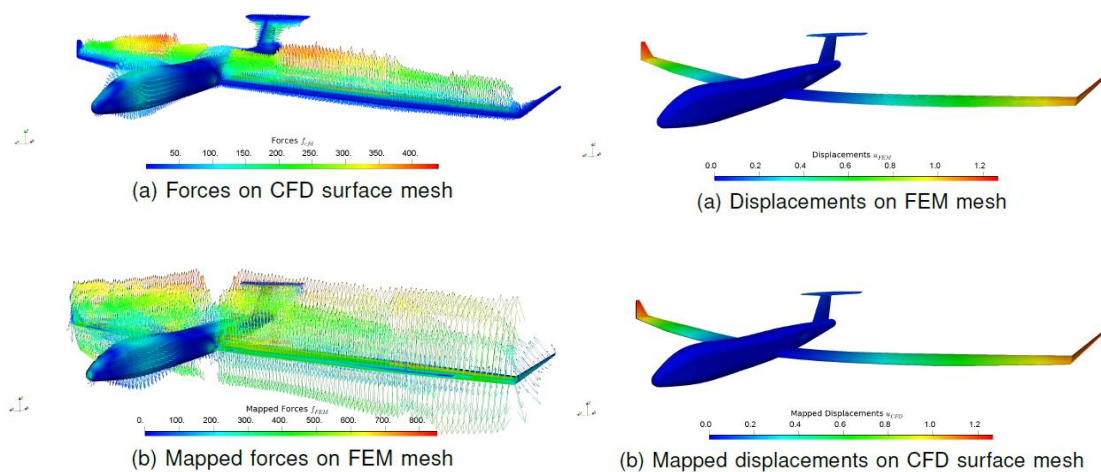

Fig. 30 Displacement-Forces mapping method [28]

The system design was performed by the Department of Mechanical and Aerospace of Politecnico di Torino. A more electric system architecture was selected for the MALE UAV aircraft. This is realized with an overall electric actuation concept except the flaps and the landing gear, which are hydraulic powered. The hydraulic pump is electrically powered and will be switched on for start and landing. For the anti-icing system it was decided to use an electro impulse. This architecture provided the best trade-off between weight and power consumption for this aircraft configuration, as illustrated in Fig. 31.

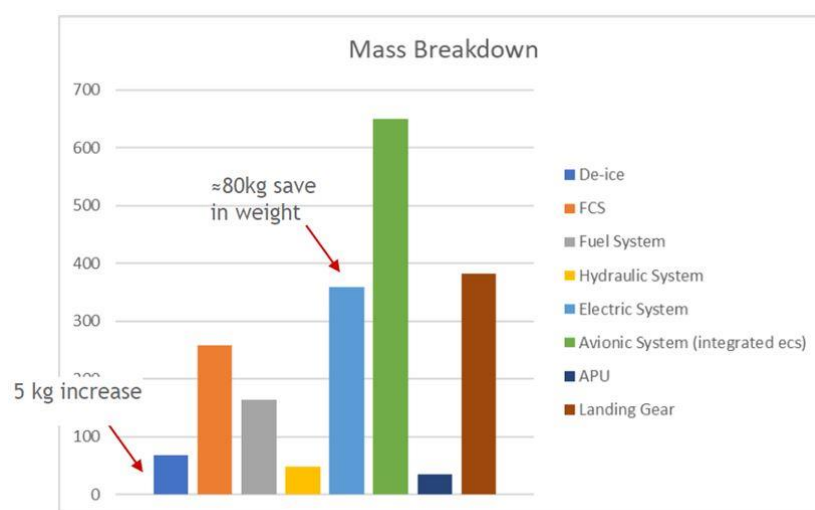

Fig. 31 On-board systems mass estimation with electric architecture

3. Overview of the main results

This section shows the actual advances of the high-fidelity aeroelastic shape optimization workflow. The thickness distribution in Fig. 32 shows the solution of the optimizer to handle the wing bending moment with the lowest amount of structural weight. The next step is to run the aeroelastic loop again with the updated structural stiffness and to converge the structural weight. Now the shape optimization can be performed and the aeroelastic- and the structural sizing loop are repeated with the updated analysis models.

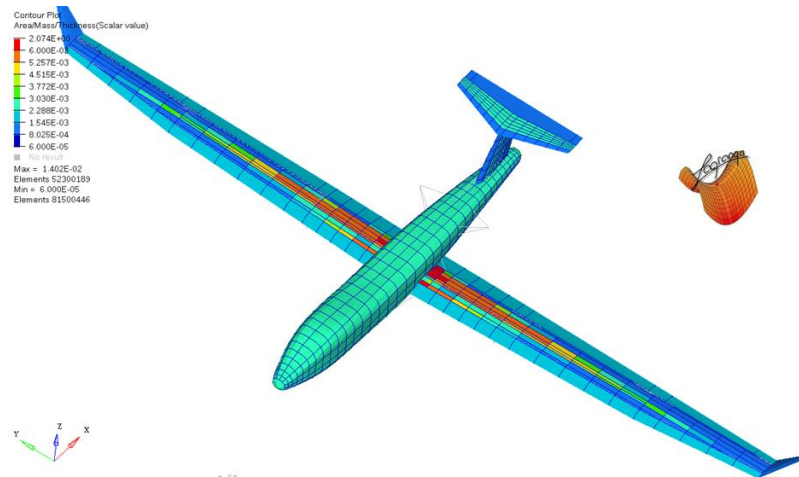

Fig. 32 Optimized aircraft structural thickness distribution

A design of experiments (DoE) was initiated with the aim to explore the design space and determine the limits of the used tools. Five geometric parameters of the wing were chosen to perform this study: the wing span and four different chord stations along the wing. To explore the corners of the design space, four updated geometry models of the MALE UAV were generated with the Airbus in-house tool *Descartes*. The wing span was altered between $+10\%$ and -5% and the four chord stations were varied between $\pm 10\%$. The presented shape optimization workflow was performed up to the endurance evaluation. Additionally, the C_{D0} was assessed for the different configurations by a turbulent skin friction method with form factor corrections.

The results of the design space exploration is shown in Fig. 33. The Maximum Zero Fuel Weight (MZFW) is obtained from the sizing optimization and the MTOW is calculated by adding the fuel mass which has a fixed weight fraction. This method was chosen to eliminate the effect of additional endurance by simply adding fuel. The lift to drag ration was obtained from different sources. The lift and the induced drag are calculated with Euler based simulation. The friction drag is provided by a correction. Finally, the endurance evaluation is performed with Equation 1. The trend, shown in this study, is going into the expected direction. It can be clearly seen, that the maximum possible endurance will not be gained if the optimization would be exclusively aerodynamic or structural, which means that neither the minimal MZFW nor the maximal $\frac{L}{D}$ can guarantee the maximum endurance of the aircraft design. The objective can only be maximized if both disciplines are regarded interdependent. More details on the AGILE MALE UAV results are reported in [30].

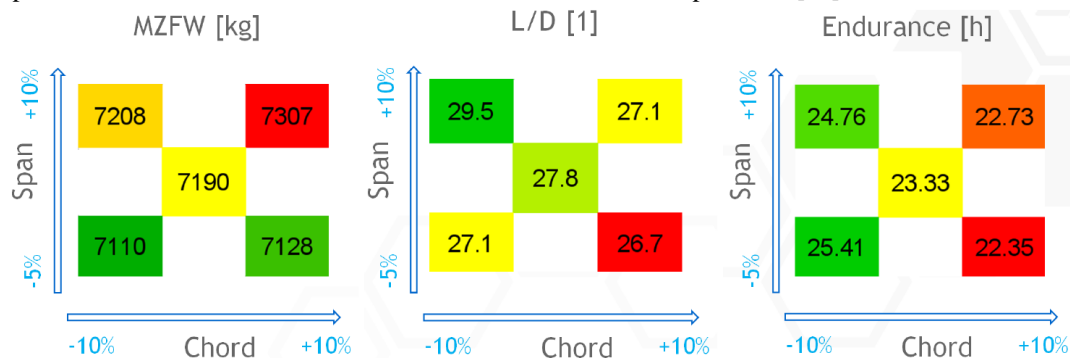

Fig. 33 MALE UAV DOE results

E. Innovative turboprop aircraft

1. Introduction use case and driving requirements

Two different turboprop configurations, named Wing-Mounted (WM) and Rear-Mounted (RM) have been designed according to the TLARs provided by Leonardo company and summarized in Table 10 (see Ref. [31]). WM configuration is a conventional high-wing and fuselage tube turboprop configuration with engine wing mounted and T-tail planes architecture. RM configuration represents a step-forward in turboprop architectures, with a low-wing and fuselage tube configuration, with conventional tail plane and engine mounted on the horizontal tail tip position. Corresponding CPACS models are shown in Fig. 34 and Fig. 35.

The main objective of this task was to show the AGILE paradigm flexibility applied to two turboprop architectures, reducing Direct Operating Costs (DOC) and Global Warming Potential (GWP).

Table 10 Regional Turbo-Prop Aircraft TLARs provided by LEONARDO Company

Requirements	AGILE Advanced Turboprop
Design Range	2222.4 km
Design payload	9540 kg
Max. payload	11590 kg
PAX	90 pax @ 106 kg
MLW (% MTOW)	97% MTOW
Cruise Mach (LRC)	0.56 @ 7620 m
Maximum Operating Altitude	7620 m
Climb Time (1500 ft to 200 FL)	13 min
TOFL (ISA, SL, MTOW)	≤1500 m
Landing distance	≤1500 m
Max. operation speed (V _{mo} / M _{mo})	270kcas/Mach 0,60
Dive Mach number (M _d)	0,64 Mach
Fuselage diameter	3.53 m – 5 abreast
Service life	≥110000 CY
Fuel reserves	5% B.F - 100 nm Alternate
Holding	30 min @ 457 m
A/C configuration	High-wing (wing-mounted engines), Low wing (rear mounted engines)
nEngine	2 - TurboProp
Design objective	Minimum D.O.C.
Emissions	Minimum GWP

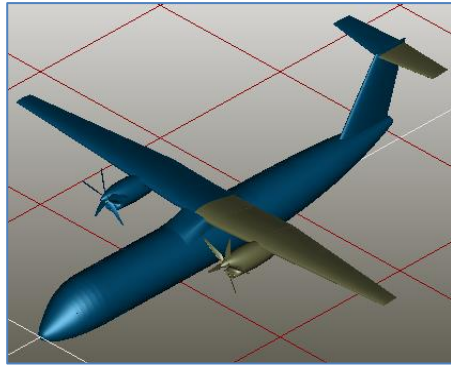

Fig. 34 WM configuration

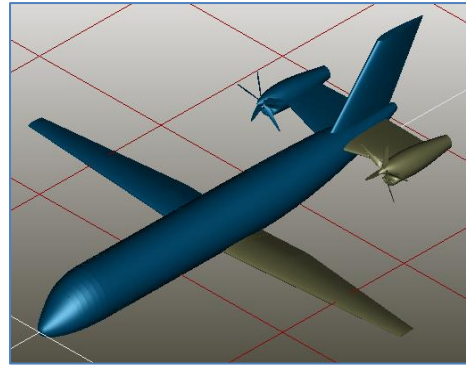

Fig. 35 RM configuration

Both configurations, WM and RM, have been preliminary size according to the TLARs. The preliminary aircraft initialization led to aircraft characterized by the same wing planform and fuselage but a different horizontal and vertical tail planes due to wing and engine position.

2. Design and optimization process formulated and implemented

One of the main advantages of the AGILE paradigm is the speeding-up of complete aircraft design workflow formulation and its standardization, leading to a common definition for different aircraft configurations. In the present test-case, the MDAO process has been formulated, defined, setting-up and executed for both aircraft configurations, changing only the input CPACS file for WM and RM aircraft. It has to be noticed that, the MDAO process is a multidisciplinary, multi-fidelity, collaborative process executed among different partners in a distributed manner.

The complete MDA workflow setup is explained in the following and shown in the schematic in Fig. 36, with evidence of involved partners and competences. The main steps are as follows:

- 1) Aircraft initialization: baseline is initialized as CPACS file (black box).
- 2) Engine deck provider: baseline engine deck is provided into CPACS file (red box), according to the engine top level requirements provided by Leonardo.
- 3) Aerodynamic competences branches: the overall aerodynamic database is performed using tools characterized by different level of fidelity. The results are updated into the CPACS file and passed to following competences (red dashed box).
- 4) Aero-structural sizing, structure weight competence: here the aircraft structural sizing is performed according the certification load cases. The aircraft empty weight is updated, and results passed to the following competences. Different levels of fidelity are provided (dashed blue box).
- 5) On-board-system design: OBS are designed and systems masses updated. Results are passed to the following competences and to Engine Design to account for power-off-takes (light green box).
- 6) Performance and mission analysis: overall aircraft performance are computed, the mission profile is simulated, and block fuel is updated (dark green box).
- 7) Mass update and rubber engine tools: aircraft mass breakdown is updated according steps (4-5-6); engine deck is scaled according to aircraft MTOW (light dashed red box).
- 8) Repeat steps 4 to 7 until Maximum takeoff weight MTOW has reached the convergence.
- 9) Stability and Control calculation (yellow block).
- 10) Costs& Emission Calculation (orange block).

The converged MDA workflow represents the skeleton for DOE and surrogate model-based optimization procedure. The purple external block in Fig. 36 contains overall MDA workflow plus two auxiliaries' tools (named morphing tools) to change main aircraft parameters. In the present applications, main wing parameters have been morphed, and tail planes have been re-designed to satisfy stability and control requirements.

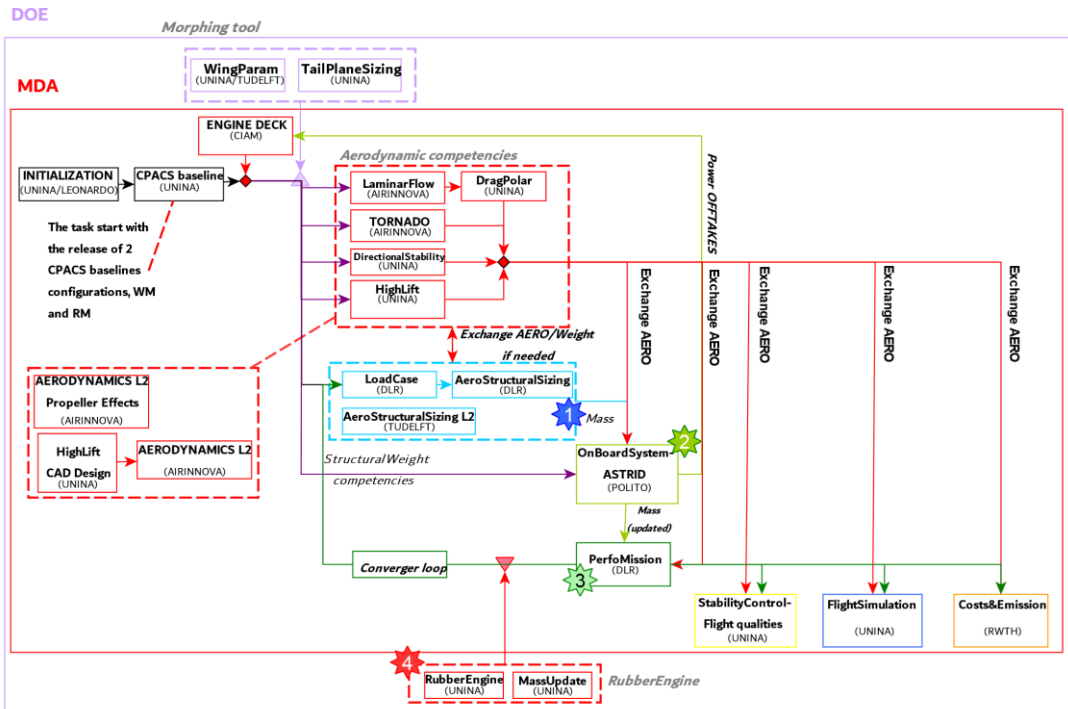

Fig. 36 Innovative turboprop MDAO workflow sketch

The “draft paper” MDAO process shown in Fig. 36 has been formulated following AGILE paradigm and the executable file make available for run as shown in Fig. 37. The DOE runs have been performed with different level of fidelity, and a data fusion has been carried out, leading to a unique response surface available to be optimized. A surrogate model-based optimization has been finally executed. The optimization problem has been defined as summarized in Table 11: the objective function for both the configurations is the DOC. Together with this, to target CleanSky2 objectives, the architect added a second objective defined as the total GWP, defined accordingly Ruijgrok and Van Paassen [32] Optimization problem constraints have been set-up accordingly the TLARs shown in Table 10. Variables are the main wing planform parameters, where X_{LEw} is the wing leading edge position along the x axis, summarized in Table 11.

Table 11 Innovative turboprop optimization problem, variables and constraints

Objective functions:	Min:
	$f_1 = DOC$
	$f_2 = GWP$
Constraints:	w. r. t:
	$SM \geq 0.05$ (5%mac)
	$TOFL \leq 1500$ m
	$LNFL \leq 1500$ m
	time to climb ≤ 13 min. (from 1500ft to 20000ft)
Variables:	by varying:
	X_{LEw}
	AR_w
	λ_w
	b_w

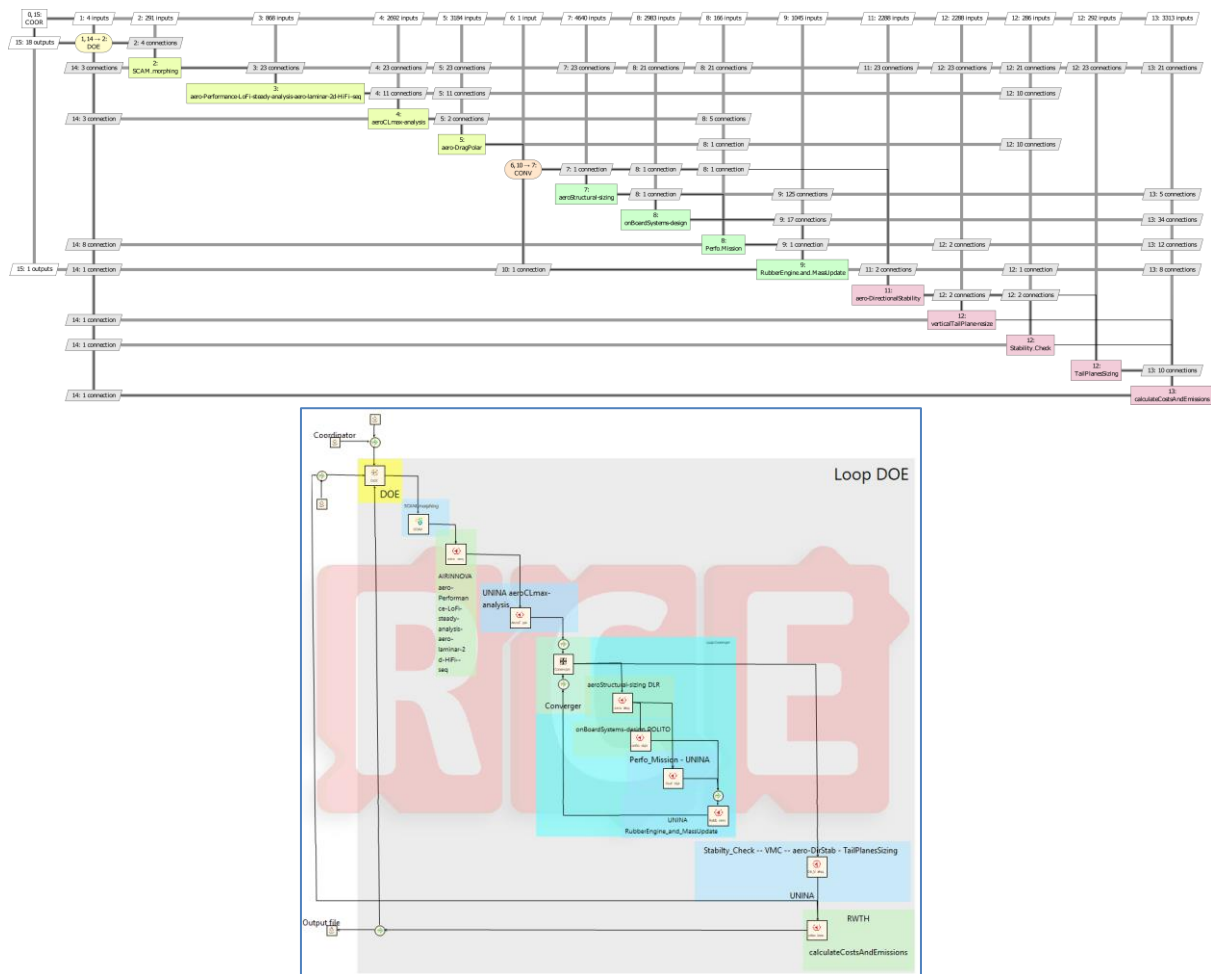

Fig. 37 Innovative turboprop DOE. Top: XDSM DOE MDA workflow. Bottom : Executable workflow imported into RCE.

3. Overview of the main results

One of the main differences between WM and RM configuration is the weight and balance and centre of gravity excursion (as shown in Fig. 38). In the RM configuration, to face stability issues, due to a high value of maximum rearward position of centre of gravity related to engine position, the wing is back shifted with respect to WM configuration, leading to a higher centre of gravity shift. Moreover, RM configuration has also a higher operative empty weight. The RM configuration has the advantage of overall clean wing (without engine and propeller slipstream), and the adoption of laminar airfoil leads to a parasite drag reduction of about 20 drag counts, as visible in Fig. 39.

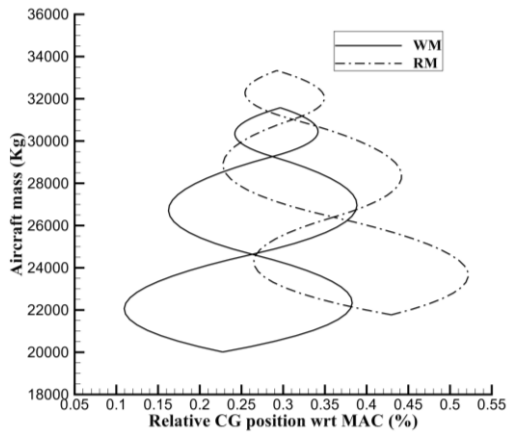

Fig. 38 WM and RM baseline. Loading diagrams comparison, MZF weight

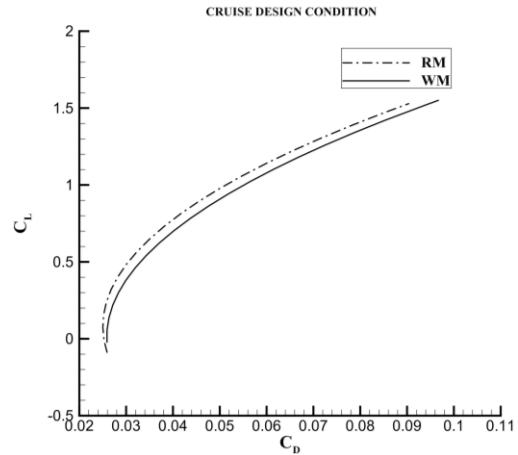

Fig. 39 WM and RM baseline. Trimmed Drag polar comparison

One of main achievements of the AGILE project has been optimization strategy based on surrogate models. In this test-cases, surrogate models have been created for the overall converged MDA shown in Fig. 37. Initially, RS have been created setting up a DOE using L0-L1 methods obtaining 280 points (aircraft), for instance, weights, structures and OBS estimated by using of semi-empirical approaches, and aerodynamic analyses characterized by the same level of fidelity. Then, the DOE workflow, was executed running L1/L2 partner's tools through, where structures have been sized according to certifications requirements, critical loads cases, aeroelasticity using FEM, OBS performed by physic-based models, and aerodynamics with L1-L2 approaches (CFD). A comparison between low-fidelity and high-fidelity DOE, applied to WM configuration is shown in Fig. 40.

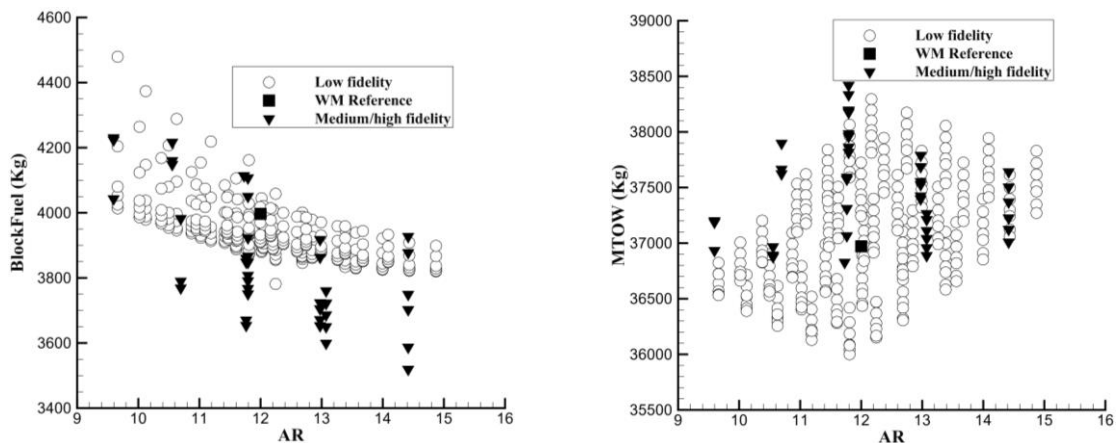

Fig. 40 Innovative turboprop DOE application to WM configuration. Left: Block fuel vs AR. Right: Maximum take-off weight vs AR.

Multiobjectives constrained optimizations have been accomplished through OMOPSO and ϵ -NSGAI optimization algorithms [31]. Main results are shown in Fig. 41 and Fig. 42 and summarized in Table 12 and Table 13. Both optimized configurations present an increased AR (around 14), with slightly reduced thickness ratio (around 16%) and negligible reduction of tailplanes area.

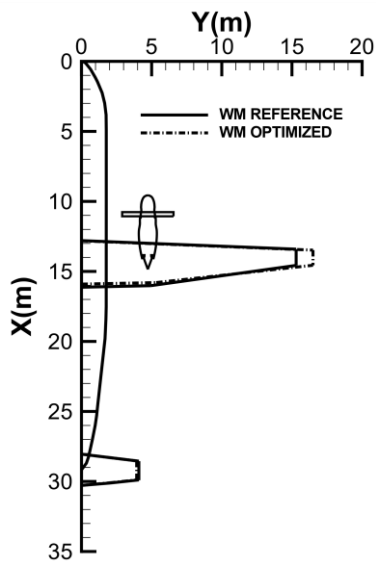

Fig. 41 WM reference and optimized layout comparison

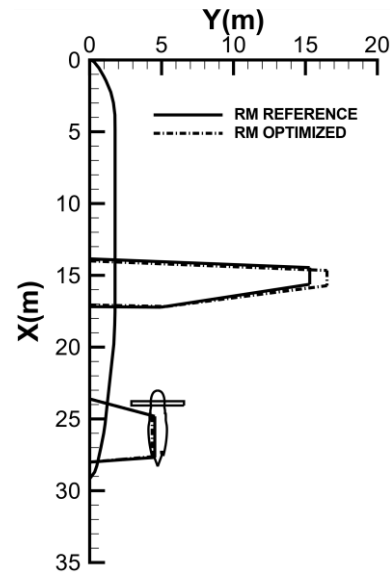

Fig. 42 RM reference and optimized layout comparison

Table 12 Objective functions comparison for WM configuration

WM layout			
	Baseline	Optimized	%
DOC (\$/flight)	17205.76	16829	2.1
DOC (Mln\$/year)	36.95	36.14	
GWP (kg/flight)	13191.58	12780.76	3.1
GWP (tons/year)	28335.52	27453.08	

Table 13 Objective functions comparison for RM configuration

RM layout			
	Baseline	Optimized	%
DOC (\$/flight)	16974.34	16767.9	0.6
DOC (Mln\$/year)	36.46	36.02	
GWP (kg/flight)	13396.86	13311.95	1.2
GWP (tons/year)	28776.45	28594.07	

Assuming a reliable number of flights per day equal to 6 for 358 days per year (considering 7 days for maintenance check A and B), it is possible to save more than 800 k\$ per year for WM and more than 440k\$ for RM in terms of DOC. Furthermore, it is possible to consider that the GWP reduction means a decrease of more than 850 tons for WM and more than 180 tons per year for RM in terms of emitted CO₂ mass. Details of overall results can be found in Ref. [31], [33].

V. AGILE Results Discussion

The paper provided the description of the 7 design cases performed during the 3rd phase of the AGILE project, Design Campaign 3. All design cases have been tackled making use of the AGILE framework, to test (and stress) the methodology and the technologies developed by AGILE, with the goal of pushing and extending the envelope of MDO technology in a collaborative design environment.

The diversity of the design cases and the novel nature of some of the aircraft configurations, were intentionally selected to assess different aspects of the AGILE framework. Some of the design cases (i.e. the turboprop and strut-braced wing aircraft) were specifically aimed at testing the agility of the overall framework, thus in supporting the iterative nature of the formulation, integration and execution of the MDAO process. Others were specifically aimed at tackling configuration specific design challenges, such as the propulsion integration on the BWB aircraft; the hi-fi aerostructural design of the slender composite wing of the MALE UAV and strut-braced aircraft; the sizing approach for redundant control surfaces of the box-wing and BWB aircraft. The Box-wing design case was used to test the optimization algorithms in case of uncertainties.

The multiple MDO tasks demonstrated the capability of the AGILE framework to meet the main objectives, namely 1) the capability to support collaborative design, bringing together tools and experts, 2) reduction of the time to set-up an MDAO system, 3) reduction of the time to convergence to optimal solutions.

The following sub-sections highlight the main advancements achieved during AGILE in streamlining the collaborative development of aircraft products.

A. AGILE Achievements

Main objectives of AGILE project are to achieve a reduction of 20% in time to converge the design of an aircraft and a 40% in time needed to setup and solve the multidisciplinary problem in a team of heterogeneous specialists. The multiple designs campaigns demonstrated the capability of the AGILE Paradigm and AGILE framework to meet the main objectives. The long set up time typical of MDO processes (including the formulation and integration phase) compared to the legacy design approach is acknowledged to be one of the main issues discouraging industry from a full adoption of MDO technology. In the last design campaign AGILE demonstrated the capability to address **7 challenging aircraft design cases in the sole period of 15 months**, where an uncountable number of workflows has been (re-)formulated, (re-)integrated and (re-)executed in 2 different PIDO tools. 15 months was the same time frame required in the first AGILE design campaign to address a single aircraft configuration (actually conventional and based on the knowledge already gained in the first design campaign) when the AGILE framework was not yet available of all its new technologies. Furthermore, for each of the 7 aircraft, more details, disciplines and experts were integrated in the MDO process (with respect to the conventional aircraft). An overall assessment representation of the overall is shown Fig. 43. It can be observed that for each phase a reduced amount of time was needed to setup a set of consistent requirements, as well as to deploy the simulation MDO processes. As a consequence more time was spent on the exploration of the design space for each of the aircraft configurations (i.e. including more disciplines, more effects, more parameters to explore).

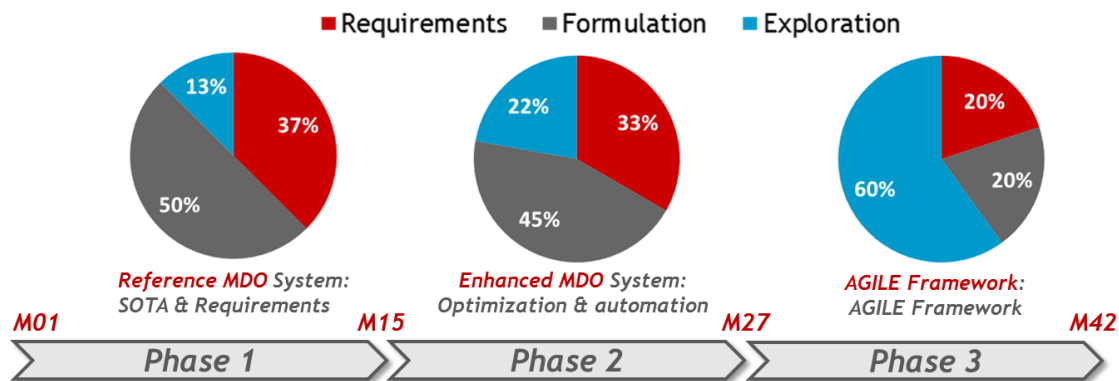

Fig. 43 Overall AGILE Progresses

Therefore, the **drastic time reduction achieved to setup and resolve the MDO problems is much beyond the AGILE objectives. The setup reduction time is estimated to be about 40% target**, and is the result of the time reduction in the **formulation and integration** phases.

Time reduction in formulation: The AGILE technologies responsible to reduce the formulation time are the aforementioned KE-chain and VISTOMS, BRICS and, most of all, KADMOS. Through its graph-manipulation approach KADMOS is able to completely automate the 3 stages of the formulation process: 1) generation of the design competence repository, 2) formulation of the fundamental optimization problem, 3) embedment of the former into one of the many MDAO strategies at hand (i.e. simple design convergence, DOE, various monolithic or distributed MDO architectures). The agility to quickly iterate from one phase to the other of the formulation process is also due to the possibility to store the intermediate results via CMDOWS

Time reduction in executable workflow integration: Thanks to CMDOWS and the dedicated CMDOWS parsers developed for RCE and Optimus, the translation of any MDAO formulation produced by KADMOS can be immediately translated into executable workflow. These workflows can include components that are actually other remote sub-workflows, possibly assembled with a different PIDO tool than the master workflow. BRICS is technology allowing the master-slave workflow component integration.

The time-to-convergence reduction challenge

Significant optimization time reductions were achieved thanks to the exploitation of 1) approximation techniques (surrogate models) and 2) advanced optimization algorithms.

Concerning the generation of the surrogate models, both existing toolboxes were used, such as the Optimus one or the NLR's MultiFit, and new/improved methods developed within AGILE, such as the co-kriging (multi-

fidelity) approach by AIRINNOVA and the ONERA-ISAE MOE (Mixture of Expert) able to combine more local surrogate models. The use of surrogate models was key to the exploitation of hi-fi analysis in the various design cases. Concerning the optimization, both existing algorithms were used, as those provided by Optimus and DAKOTA, and newly developed ones, such as the multi-objective NGA by UNINA (**40% faster** than other GA based MOO methods) and the SEGOMOE by ONERA-ISAE (**factor 8 reduction in number of iterations**).

MDO vs Level of fidelity boundary extension challenge

Performing true MDO using many and high fidelity tools is extremely challenging. Typically, the level of fidelity of the involved tools needs to be lowered to perform multidisciplinary optimization. Alternatively, the scope of the MDO exercise must be reduced from full-blown MDO to trade-off studies or limited optimization accounting only for a few disciplines (typically limited to aero, structures, cost, performance).

The design cases tackled in the 3rd AGILE design campaign, demonstrated the potential of the AGILE framework and its technologies to push the SOTA boundary, both in terms of the amount and level of fidelity of the disciplines involved in the MDO effort, as qualitatively illustrated in Fig. 44.

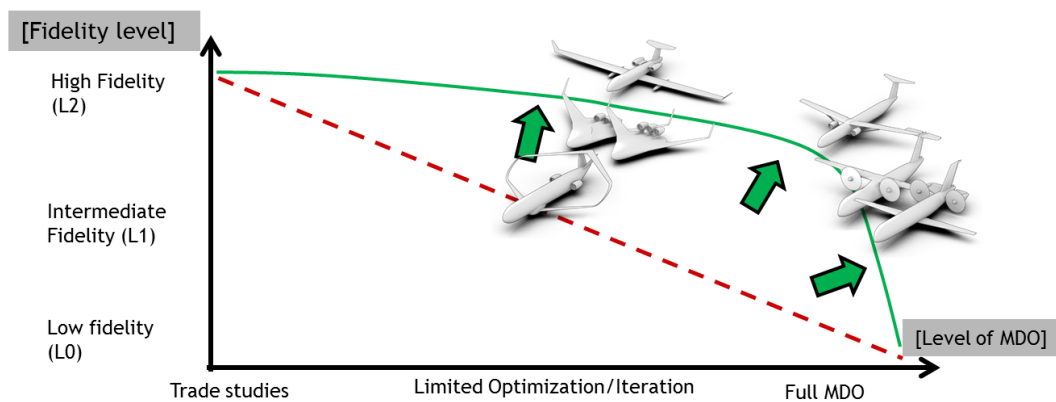

Fig. 44 fidelity level vs. level of MDO: in red the SOTA boundary, in green the AGILE extended boundary

The qualitative positioning of the design cases in the plot shows two clusters, which correlate to the “level of novelty” of the aircraft configurations. It was not possible to achieve the same level of MDO with the BWB and the Box-wing cases, not because of limitations in the AGILE paradigm or technologies, but in some of the disciplinary tools to deal with the unconventionality of those configurations (given the limited time available in the project to upgrade those tools). Also the UAV design case could have possibly achieved a higher level of MDO.

Concerning the amount and typology of disciplines involved in the use cases, AGILE demonstrated the ability - and the actual necessity - to include in the MDO effort extra key disciplines, besides the usual aerodynamics, structures, etc. These extra disciplines are illustrated in Fig. 45, together with the specific design cases of application:

- **on board system sizing and analysis:** this enabled assessing the impact of the all-electric system architecture on the turboprop design cases; selecting the de-icing system for the MALE UAV; and revealing the extra weight and power offtake of buried engines option w.r.t. to the podded solution on the BWB design.
- **airframe propulsion system integration:** the importance of this “novel discipline” was demonstrated in the BWB case (podded vs buried with BLI), in the Strut-braced aircraft case, as well as for both the turboprop cases, always supported by hi-fi analysis.
- As a consequence of the two above, also the classic propulsion discipline could be extended beyond the classic “rubberization approach”, and included not only all off-design cases, but also the effect of the on board systems installation and power offtake.
- The strut-braced aircraft also demonstrated the convenience of **composite tailoring techniques** to size very slender wings accounting for the aeroelastic effects
- The incorporation of **advanced control methods** for redundant control surfaces architectures (BWB and Box-wing design cases) and **climate impact estimations** methods (Strut-braces and turboprops) are other relevant examples of new (or renewed) key disciplines to address the innovative configurations for future aviation

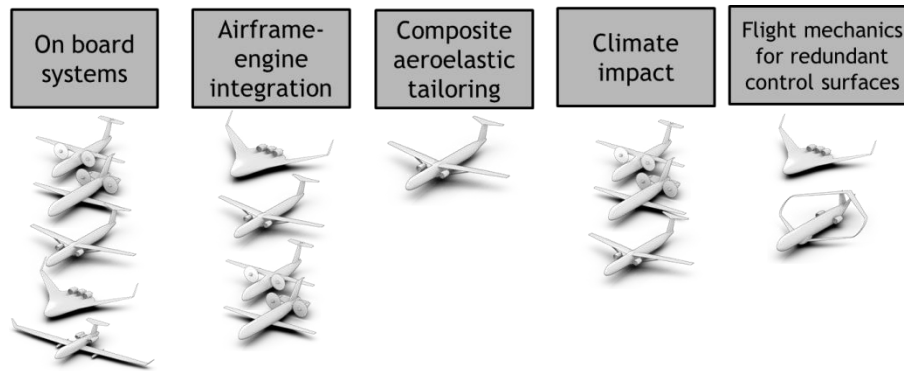

Fig. 45 extra disciplines involved by AGILE in the MDO effort

B. AGILE Technologies

The AGILE technologies responsible for the achievement of the collaboration objective are the following:

- CPACS, the central data schema enabling all the tools in the design competence repository to exchange their I/O data. As far as a design competence provided by any of the partner was CPACS compliant (CPACSSized), its integration in the MDAO workflows was practically effortless.
- CMDOWS, the neutral schema used to store and communicate MDAO system throughout their phases in the formulation process (e.g. as tool repository, as fundamental optimization problem or as complete MDAO strategy).
- VISTOMS, the application to visualize the CMDOWS files and support debugging and communication of intent between the various actors involved in the formulation of the MDAO system
- KE-chain the cockpit to integrate, set and control the whole development and utilization of the MDAO systems, providing specific instruction to each individual actor involved in the process and information on the actual state of action
- SMR, the on line system to store, access and distribute the surrogate models generated by the various parties
- BRICS, the technical solution to enable the integration of locally installed and running tools (or workflows) as remote services for the overall MDAO workflows. This enabled the easy and secure sharing of design competences operating from within protected system environment under the direct control of the specialist

C. Main Deliverables from the AGILE Project

The AGILE project delivers two main final open access outcomes:

1. The “AGILE novel aircraft configurations database”.

This database is the use-cases collection and contains extensive results and digital models of the 7 novel aircraft configurations, designed and optimized for reduced environmental impacts. The database is available on the AGILE portal, where registered users can download a use-case package. For each aircraft configuration, the package include the aircraft configurations digital models (e.g. CAD, CPACS, FlightGear simulator models as shown in Fig. 46), the design and optimization processes implemented (e.g. XDSM), the design exploration and optimization studies’ results, and other discipline specific outcomes.

2. The “AGILE Open MDO suite”.

The suite contains the AGILE design and optimization technologies, providing accessibility to a very large-sale number of organizations and applications, even beyond the aeronautical field. The suite is made accessible to externals in multiple ways from the AGILE portal: 1) via a web-based application hosted on the portal (users can use it as they would navigate on a web page); 2) via a virtual machine containing all the needed components and ready to be used, which enables customization from the users perspective (shown in Fig. 47); 3) via a series of repositories hosting the individual technologies. Extensive tutorials, examples and videos have been prepared.



Fig. 46 AGILE Novel configurations (left) available in the database and corresponding CPACS models (middle) and FlightGear models (right).



Fig. 47 AGILE Open MDO Suite as Virtual Machine distribution

VI. Beyond AGILE Technologies

The AGILE Project has provided a set of technologies and capabilities supporting the AGILE Paradigm.

- Main challenges encountered by AGILE and envisioned enhancements to be mentioned are:
- The formalization of view points for each of the roles defined within the implemented framework
- The extension of modeling languages for product and processes
- The additional of reasoning criteria within the deployment of MDO processes such as credibility of models
- Mechanisms supporting formal verification and validation of the product and process models
- Enhancing of query capabilities for the models from the framework solutions
- Integration of data analytics techniques to support the decision making
- Enhancement of traceability and versioning of the designed products and deployed processes

Currently many of the technologies are exploited and evolving beyond the AGILE project on the basis of the AGILE lessons learned as well as novel components are under development to address the open challenged at the conclusion of the project. Currently a follow-on project has been planned and will continue the AGILE activities, especially looking at:

- The extension of the AGILE Paradigm formalization towards a full MBSE approach.
- The application of the AGILE Paradigm to other domains of the product life cycle (e.g. production, maintenance, certification).
- The extension of the AGILE Paradigm to the upstream phases of the system engineering development cycle (e.g. derivation of functional and logical architectures) and bridging to the MDO deployment.

Appendix

The appendix collects a selection of the XDSM representations of the MDO processes formulated and discussed in the paper for the AGILE MDO use-cases.

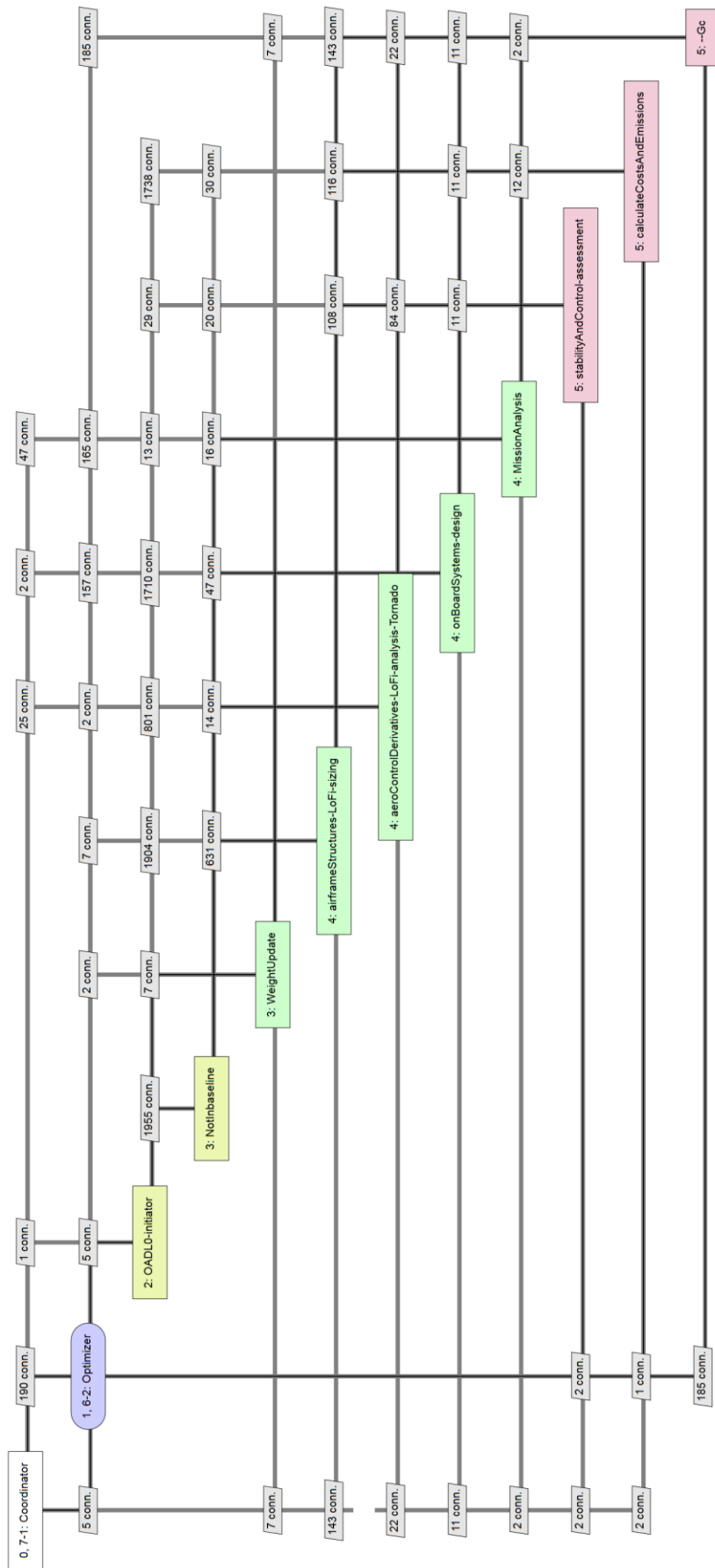

Fig. 49 XDSM Box-wing Aircraft – MDF Architecture

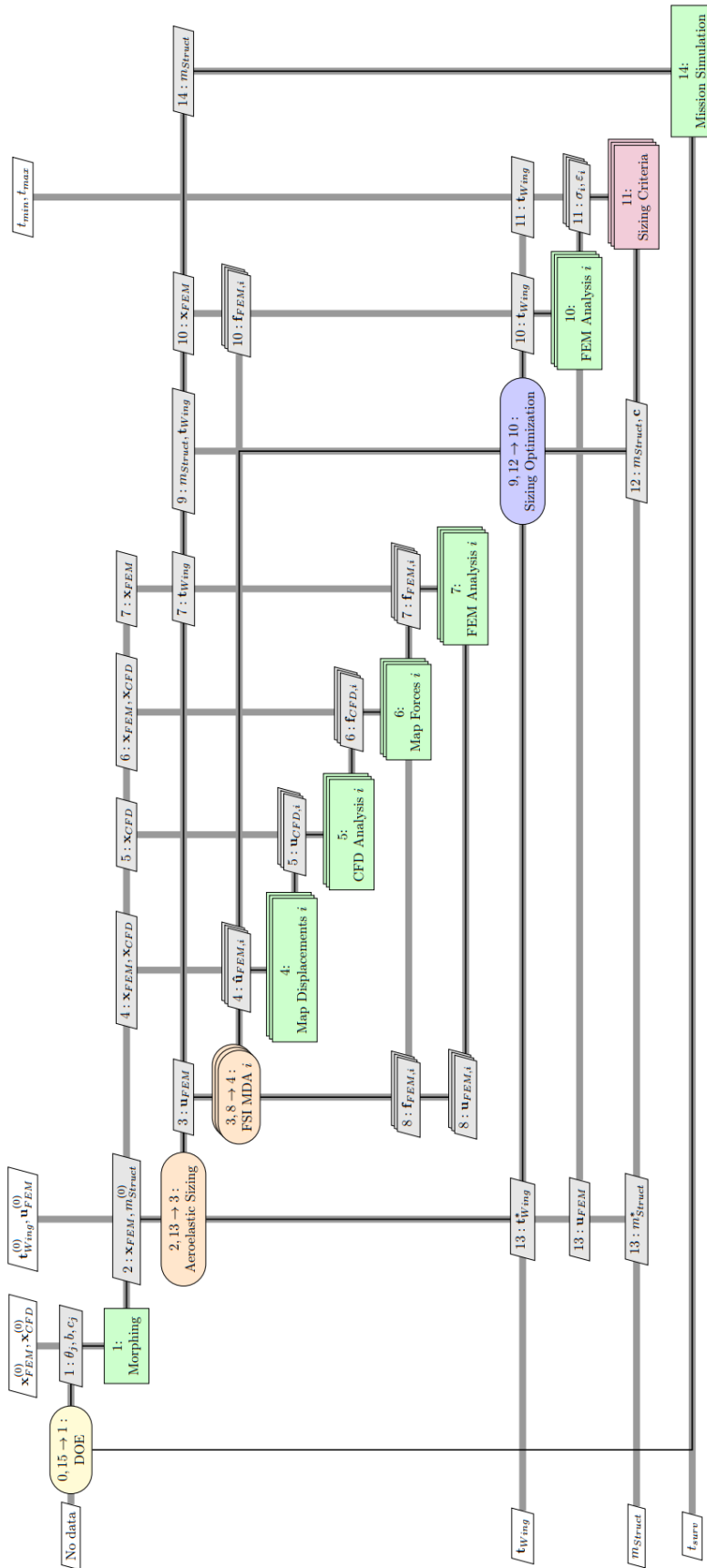

Fig. 50 XDSM MALE UAV – DOE MDA Architecture

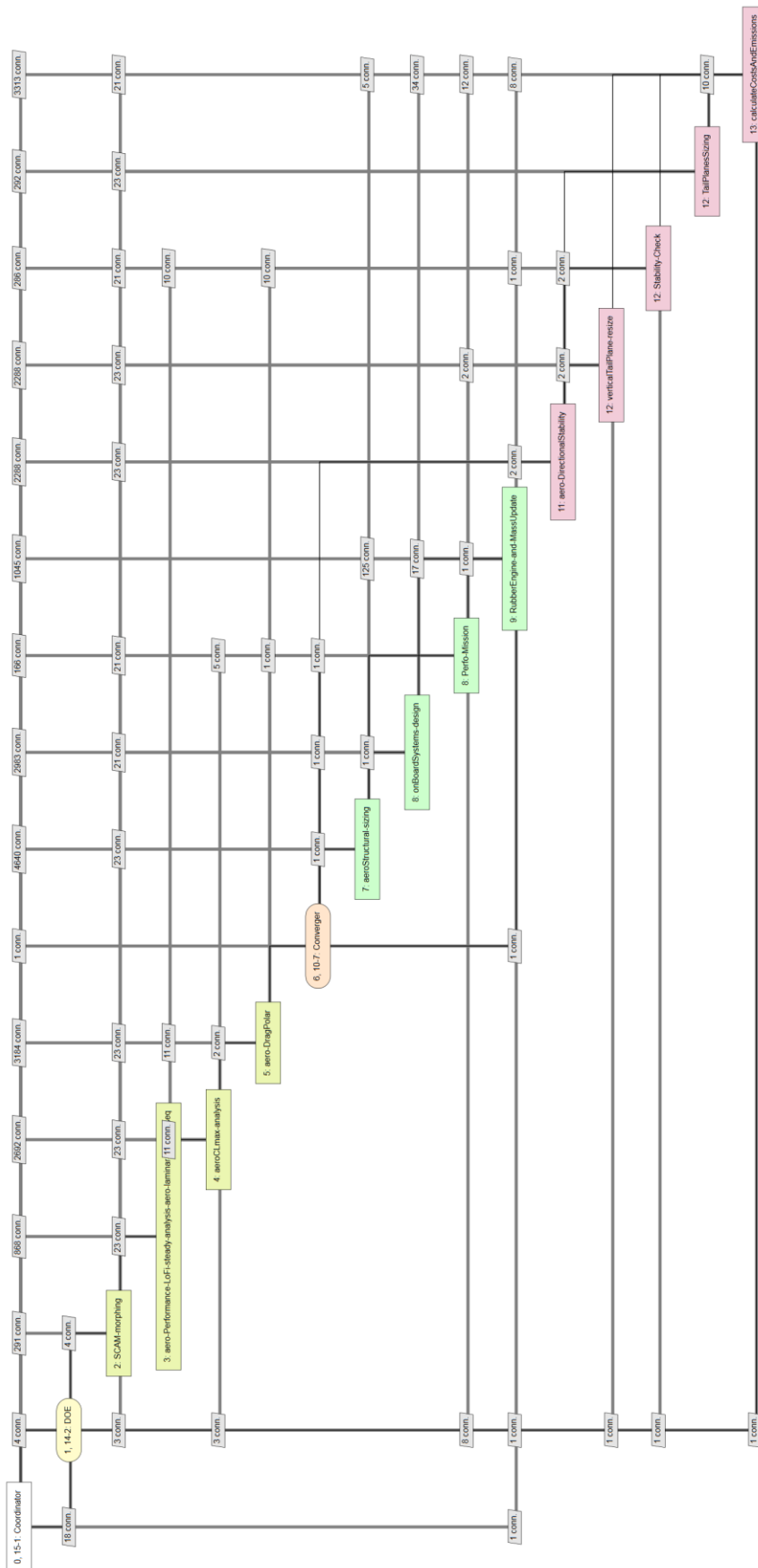

Fig. 51 XDSM Advanced Turboprop Wing Mounted – DOE MDA Architecture

Acknowledgments

The research presented in this paper has been performed in the framework of the AGILE project (Aircraft 3rd Generation MDO for Innovative Collaboration of Heterogeneous Teams of Experts) and has received funding from the European Union Horizon 2020 Programme (H2020-MG-2014-2015) under grant agreement n° 636202. The authors are grateful to the partners of the AGILE Consortium for their contribution and feedback.

References

- [1] P. D. Ciampa and B. Nagel, "Towards the 3rd generation MDO collaboration Environment," in *30th ICAS Congress*, Daejeon, Korea, 2016.
- [2] *AGILE, Project portal*. .
- [3] P. D. Ciampa and B. Nagel, "The AGILE Paradigm: the next generation of collaborative MDO," in *18th AIAA/ISSMO Multidisciplinary Analysis and Optimization Conference*, 2017.
- [4] P. D. Ciampa, "AGILE Paradigm: the next generation collaborative MDO for the development of aeronautical systems," *Progress in Aerospace Sciences*, vol. Submitted, May 2019.
- [5] P. D. Ciampa, E. Moerland, D. Seider, E. Baalbergen, R. Lombardi, and R. D'Ippolito, "A Collaborative Architecture supporting AGILE Design of Complex Aeronautics Products," in *18th AIAA/ISSMO Multidisciplinary Analysis and Optimization Conference*, 2017.
- [6] P. D. Ciampa and B. Nagel, "AGILE the Next Generation of Collaborative MDO: Achievements and Open Challenges," in *2018 Multidisciplinary Analysis and Optimization Conference*, 2018.
- [7] *KE-chain website*. .
- [8] *DLR, German Aerospace Center, CPACS – A Common Language for Aircraft Design*. .
- [9] I. van Gent, G. L. Rocca, and M. F. M. Hoogreef, "CMDOWS: a proposed new standard to store and exchange MDO systems," *CEAS Aeronautical Journal*, vol. 9, no. 4, pp. 607–627, May 2018.
- [10] B. Aigner, I. van Gent, G. L. Rocca, E. Stumpf, and L. L. M. Veldhuis, "Graph-based algorithms and data-driven documents for formulation and visualization of large MDO systems," *CEAS Aeronautical Journal*, vol. 9, no. 4, pp. 695–709, Jun. 2018.
- [11] I. van Gent, G. La Rocca, and L. L. M. Veldhuis, "Composing MDAO symphonies: graph-based generation and manipulation of large multidisciplinary systems," in *18th AIAA/ISSMO Multidisciplinary Analysis and Optimization Conference*, Denver, USA, 2017.
- [12] *Noesis Solutions, Optimus Rev 10.19 - Users Manual*. Noesis Solutions, 2017.
- [13] *DLR, German Aerospace Center, RCE*. .
- [14] E. Baalbergen, J. Kos, C. Louriou, C. Campguilhem, and J. Barron, "Streamlining cross-organisation product design in aeronautics," *Proceedings of the Institution of Mechanical Engineers, Part G: Journal of Aerospace Engineering*, p. 0954410017716480, 2016.
- [15] F. H. Gern, A. H. Naghshineh-Pour, E. Sulaeman, R. K. Kapania, and R. T. Haftka, "Structural Wing Sizing for Multidisciplinary Design Optimization of a Strut-Braced Wing," *Journal of Aircraft*, vol. 38, no. 1, pp. 154–163, Jan. 2001.
- [16] E. Sulaeman, R. Kapania, and R. Haftka, "Parametric Studies of Flutter Speed in a Strut-Braced Wing," in *43rd AIAA/ASME/ASCE/AHS/ASC Structures, Structural Dynamics, and Materials Conference*, 2002.
- [17] E. Moerland *et al.*, "On the Design of a Strut-Braced Wing Configuration in a Collaborative Design Environment," in *17th AIAA Aviation Technology, Integration, and Operations Conference*, 2017.
- [18] F. Torrigiani *et al.*, "Design of the Strut Braced Wing aircraft in the AGILE Collaborative MDO Framework," Belo Horizonte, Brazil, 2018.
- [19] *PARSIFAL Project portal*. .
- [20] V. Cipolla, A. Frediani, K. A. Salem, M. P. Scardaoni, A. Nuti, and V. Binante, "Conceptual design of a box-wing aircraft for the air transport of the future," in *2018 Aviation Technology, Integration, and Operations Conference*, 2018.
- [21] T. Lefebvre *et al.*, "Methodological enhancements in MDO process investigated in the AGILE European project," in *AVIATION/AIAA 2017, 18th AIAA/ISSMO Multidisciplinary Analysis and Optimization Conference*, Denver, United States, 2017.
- [22] N. Bartoli *et al.*, "An adaptive optimization strategy based on mixture of experts for wing aerodynamic design optimization," in *18th AIAA/ISSMO Multidisciplinary Analysis and Optimization Conference*, Denver, USA, 2017.
- [23] P. S. Prakash *et al.*, "Model Based Collaborative Design & Optimization of Blended Wing Body Aircraft Configuration: AGILE EU Project," in *2018 Aviation Technology, Integration, and Operations Conference*, 2018.
- [24] A. Mirzoyan *et al.*, "Propulsion System for BWB Configurations in the Agile project," in *2018 Joint Propulsion Conference*, 2018.

- [25] M. Fioriti, L. Boggero, S. Corpino, P. S. Prakasha, P. D. Ciampa, and B. Nagel, "The Effect of Subsystems Design Parameters on Preliminary Aircraft Design in a Multidisciplinary Design Environment," *Transportation Research Procedia*, vol. 29, pp. 135–145, 2018.
- [26] K. Anisimov, A. Savelyev, I. Kursakov, A. Lysenkov, A. Mirzoyan, and P. S. Prakasha, "Propulsion System – Airframe Integration and Optimization of Civil Aircraft – AGILE EU Project," Belo Horizonte, Brazil, 2018.
- [27] K. Elssel and Ö. Petersson, "AeroStruct - Schlussbericht," 2016.
- [28] J. N. Walther, A. Gastaldi, A. Jungo, M. Zhang, and R. Maierl, "Integration Aspects of the Collaborative Aero-Structural Design of an Unmanned Aerial Vehicle," Friedrichshafen, DE, 2018.
- [29] G. Schuhmacher, D. Fernass, Ö. Petersson, and M. Wagner, "Multidisciplinary Airframe Design Optimization," presented at the 28th International Congress of the Aeronautical Sciences, Brisbane, Australia, 2012.
- [30] R. Maierl *et al.*, "Aero-Structural Optimization of a Male Configuration in the AGILE MDO Framework," Belo Horizonte, Brazil, 2018.
- [31] P. D. Vecchia *et al.*, "Advanced turboprop multidisciplinary design and optimization within AGILE project," in *2018 Aviation Technology, Integration, and Operations Conference*, 2018.
- [32] G. J. J. Ruijgrok and D. M. Van Papssen, *Elements of Aircraft Pollution. Delft: Delft University*. Delft: TUDelft University, 2005.
- [33] L. Stingo, P. D. Vecchia, and G. Cerino, "MDO Applications to Conventional and Novel Turboprop Aircraft within the AGILE European Project," Belo Horizonte, Brazil, 2018.